

广东库博精密科技有限公司

GUANGDONG UNIHOPPER PRECISION TECHNOLOGY
CORPERATION LIMITED

运营中心：广州市天河区天河路 242 号丰兴广场 B 栋 2404 室
Operating center: Rm2404 Building B, Fengxing Plaza, No.242,
Tianhe Rd, Tianhe District, Guangzhou City

总部：肇庆高新技术产业开发区创业路 9 号库博工业园
Headquarter: Unihopper industrial park, No.9 Chuangye
road, High-tech Industrial Development Zone ,Zhaoqing City,
Guangdong Province, China

TEL: 0758-3212900/3212901
FAX: 0758-3212902
E-mail: sales@unihopper.biz

www.unihopper.biz

2303-10K



公众号



微官网

库博五金保留在不影响功能质量前提下，适当改动尺寸、外型而不另行通知。实际产品会因印刷原因与样本上有少许色差，产品图片尺寸误差以实物为准
On the premise of not influence the function and uality,Grasshopper reserves the right of changing the size,outlook without notice.
There will be a little color difference between the product in presswork and definite object.The correct size of the product subject to definite object.

KITCHEN

Designed by UNIHOPPER



KITCHEN 厨房五金产品手册

KITCHEN

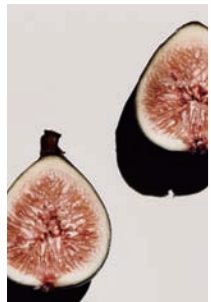

K

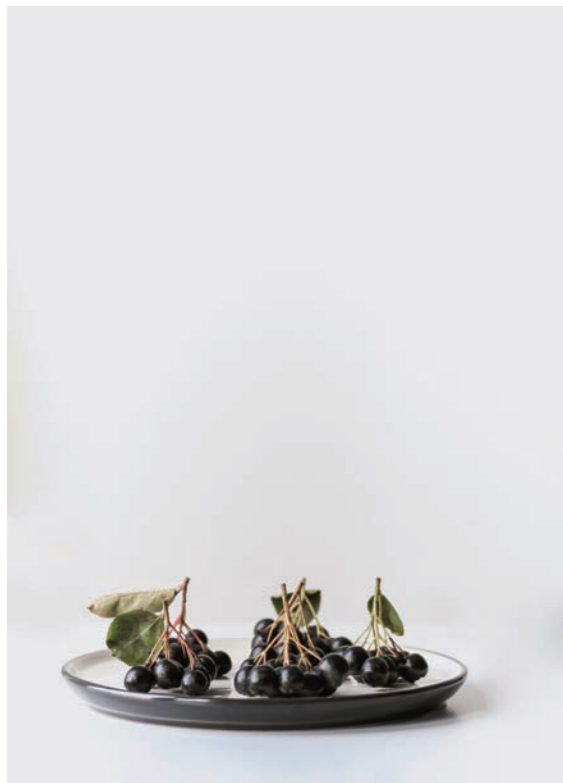

S

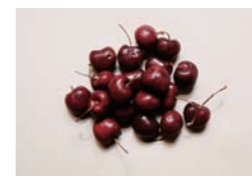

KITCHEN

STORAGE SYSTEM



Unihopper Intelligent industrial park
库博智能化工业园



Unihopper R & D Building
库博研发大楼

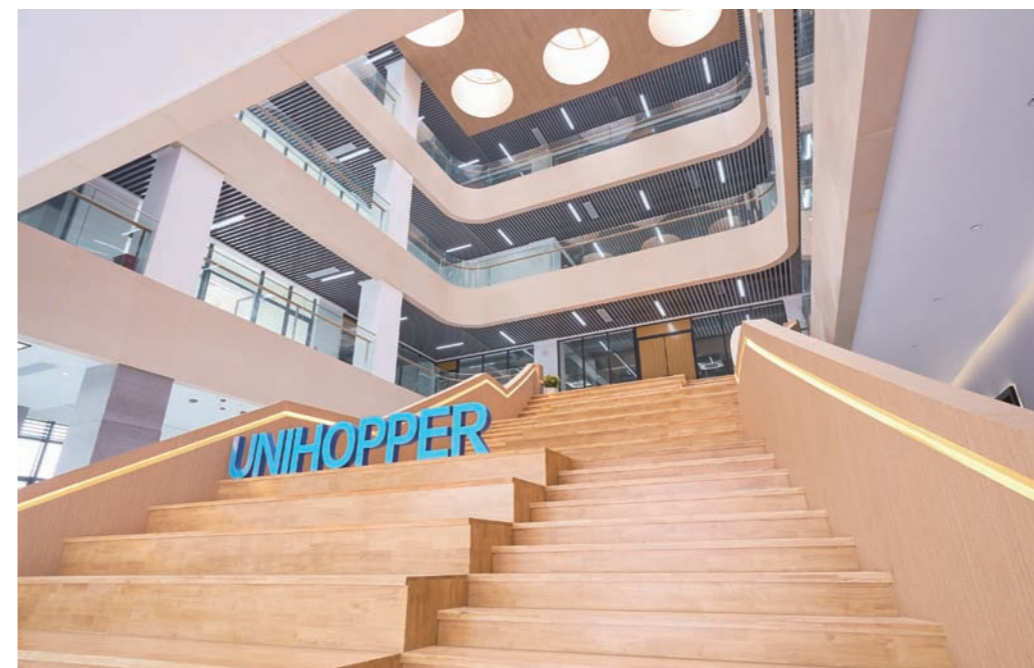

MILESTONES

品牌里程碑

2003 >

库博在中国广州成立销售公司，并成功推出第一代单缓冲骑马抽。

Unihopper founded the company in Guangzhou, and launch the first generation one-way soft closing drawer box.

2005 >

库博决定投建佛山生产基地，引进欧洲先进技术，在中国进行生产。

Unihopper decided to invest with the advanced technology from Europe and construct the production base in FOSHAN of China.

2007 >

库博与欧洲、哥伦比亚设计师成立联合设计小组，并成功推出第二代双缓冲骑马抽，双缓冲理念在此风靡全球。

Unihopper founded a union design group with designers from Europe and Columbia, and successfully launch the second generation two-way soft closing drawer box. The concept of twoway soft closing became popular around world ever since.

2008 >

库博组建营销中心，开始为中国家具客户提供优质的产品和服务。

Unihopper set up the marketing center and began to provide quality products and service for Chinese furniture customers.

2010 >

成功研发第三代联动双缓冲骑马抽及同步隐藏导轨。

Unihopper successfully researched and developed the third generation interactive two-way soft closing drawer box and synchronize conceal slide.

2013 >

联合设计小组成功研发拉篮和衣柜收纳系统（摩卡系列）。

The union design group successfully researched and developed basket and wardrobe storage system (MOKA).

2015 >

成功研发第五代联动双缓冲骑马抽 – 魔力抽，并在北京衣柜年会成功举办“库博之夜”。

Unihopper successfully researched and developed the fifth generation interactive two-way soft closing drawer box-Magic box, and successfully hosted the “Night of Unihopper”in Beijing wardrobe annual conference.

2016 >

在广州成功举办库博峰会，并宣布 UNIHOPPER 库博全球化。

Unihopper successfully hosted “Unihopper summit conference” in Guangzhou, and announced Unihopper would globalize the brand.

2017 >

成功举办第二届库博全球合作伙伴峰会，同时库博商学院成立。

Unihopper successfully hosted the second “Unihopper summit conference”. Same time, Unhopper Business College was founded.

2019 >

成功举办第三届库博全球合作伙伴峰会，库博新生产基地奠基及库博“9月9日品牌日”成立；同年研发出魅影系列厨房收纳和酷力抽系列产品。

Unihopper successfully hosted the third “Unihopper summit conference”, and founded the new Unihopper production base and Unihopper brandday. Same year, Unihopper researched and developed the Phantom kitchen storage system and Co-box.

2020 >

库博成为全装修家居五金铰链、导轨、拉篮使用标准主起草单位；荣获国家高新技术企业。梵卡、酷卡等原创新品相继推向市场。

Unihopper become one of the home decoration drafting committee for Hinge, slide and basket. In the same year, Unihopper won the National High-tech Enterprise. Vanka, COKA have been introduced to the market.

2021 >

库博 肇庆高新区产业园正式投入使用；丽影、库格系列新品推出。

Unihopper new production base put into use officially. LINA, HUGGEN have been introduced to the market.

2022 >

库博国际研发中心与新总部旗舰产品体验厅全面对外开放；库博与万科采筑共建产品研发中心、产品国家实验室。

Unihopper international R&D center and the flagship showroom in the new headquarters fully open to the public, same time, Unihopper establish product R&D centre and product laboratory together with Vanke caizhu.

BRIEF INTRODUCTION

集团介绍

Unihopper, a high-end customized home brand and the provider for comprehensive solutions of hardware supporting, implements the "Belt and Road" global development strategy to develop the global market. Offering the Uni-products, Uni-design, and Uni-service to every corner of the world.

After years of development, Unihopper has sole agents in dozens of countries and regions around the world, such as Netherlands, Canada, Russia, Slovenia, Argentina, Korea, Iran, Spain, Portugal, Ireland, Saudi Arabia, Colombia, South Africa, India, Southeast Asia Regions and China HongKong, Macao and Taiwan regions and so on; and now, Unihopper has become a major suppliers for many well-known cabinet and home brands in the world. In China, many listed furniture enterprises are our Uni-partners including OPPEIN, PIANO, SOGAL, ZBOM, Haier, OLO and so on. At the same time, Unihopper is also the major suppliers of Vanke, LONGFOR, POLY, China Overseas and many other real estate companies in China.

In 2005, Unihopper set up a production base and established a large storage center in Nanhai city in China, and a new intelligent Uni-industrial park of more than 120,000 square meters will also be put into use in 2021. As one of the best name and provider for the high-end customized furniture hardware industry, Unihopper has always upheld the brand values of "European quality, Chinese price", and now, has become a leading brand popularizing in many home furnishing companies and consumers all over the world. In the future, Unihopper will increase more investment in space enlarging, strengthen multi-dimensional development including product application, intelligent scene introduction, online and offline channel integration, striving to become the best home storage master around consumers' life.

Unihopper 库博是一家致力于全球化发展的定制家居五金及五金配套解决方案的供应商。库博实行“一带一路”全球发展战略，开放的胸怀开拓全球市场。将库博的产品、文化、理念推广到世界每个角落。

经过多年的发展，UNIHOPPER 库博在荷兰、加拿大、俄罗斯、斯洛文尼亚、阿根廷、韩国、伊朗、西班牙、葡萄牙、爱尔兰、沙特、哥伦比亚、南非、印度、东南亚地区以及中国港澳台地区等全球数十个国家和地区设有独家代理，现已成为全球众多知名橱柜和家居品牌的主要供应商。在华许多上市家居企业均是库博合作伙伴，包括有：欧派、索菲亚、志邦、海尔、我乐等，同时库博品牌也是万科、龙湖、保利、中海等众多地产公司的主要供应商。

2005年，Unihopper 库博在中国佛山南海设立了生产基地并建立了大型仓储中心。全新超 12 万平方米智能化库博工业园已在 2021 年投入使用。作为一家高端定制家居五金供应商，Unihopper 库博一直坚持原创设计，“价格不上，品牌不下”的营销理念，已然成为全球众多家居企业和消费者追随的行业领导品牌，未来库博集团将加大更多空间投入，将产品运用、智能化场景导入、线上线下载体化等多维度发展，努力打造成为消费者身边最出色的家居收纳大师。



THE LAYOUT OF UNIHOPPER ALL OVER THE WORLD

全球布局



COMPANY VISION

库博的理念

企业使命
CORPORATE MISSION:

满足人们对美好生活的向往是库博人的使命追求
To meet people's yearning for a better life is the mission
pursuit of Unihopper

价值观
VALUES:

诚信、利他、奋斗、创新、理解、共进
Integrity, altruism, struggle, innovation, understanding,
common progress

INDEX

目录

P

PHANTOM

魅影

P.011-068

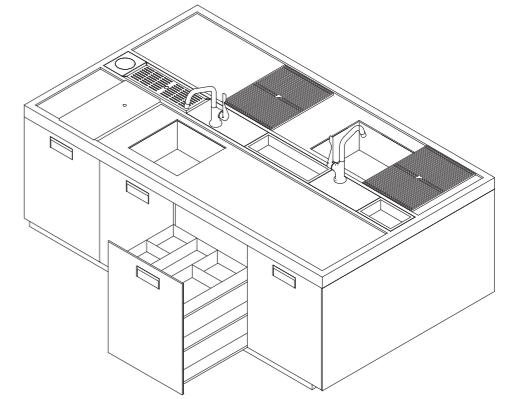

L

LINA

丽影

P.069-090

VINA

慧影

P.091-100

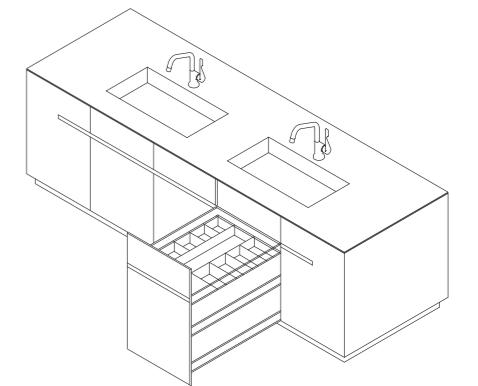

N

NANO

纳米

P.101-158

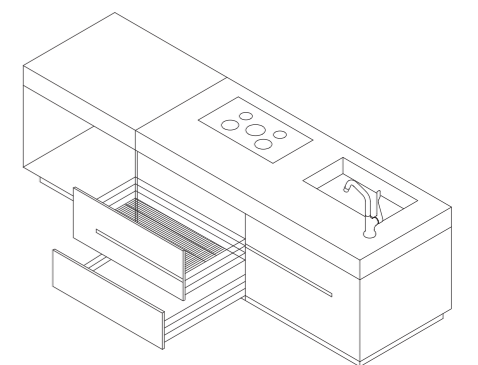



PHANTOM STORAGE SYSTEM

魅影系列



GLASS SWIVEL PULL-OUT BASKET

魅影高柜 / 中柜 / 地柜联动拉篮





SYNCHRONIZED STRUCTURE BRINGS YOU EASY STORAGE AND SMOOTH OPENING. HEAVY DUTY SLIDE, WITH MORE LARGER LOADING CAPACITY, STORAGE KITCHEN STUFFS AS POSSIBLE AS YOU CAN.

独特的连动设计，在开门的同时带出全部篮子，方便存放物品。静音开启，使产品在开合过程中，始终保持平稳、顺畅的效果。重型导轨，强化产品的承载能力，并使拉出保持平稳。





SOFT CLOSING GLASS SWIVEL PULL-OUT BASKET



THE PERFECT COMBINATION OF BEAUTY AND STORAGE HIGHLIGHTS YOUR KITCHEN LIFE.
去繁就简，窥见生活简练一面。美观与储物完美结合，让梦想厨房更贴近您的生活。



Soft Closing Glass Swivel Pull-out Basket



魅影高柜联动拉篮



→ FEATURES / 产品特点

- Perfect connection between basket and door soft closing
拉篮与门板巧妙连接，联动开启，缓冲关闭
- Flat glass basket and heavy duty slide
玻璃防滑六层篮，重型滑轨
- Clear classification, more storage space, convenient and smooth operation
分类存储各种物品，存储量大，收取便利
- Color: Dark grey
颜色：深灰色



→ TECHNICAL DETAILS / 技术参数

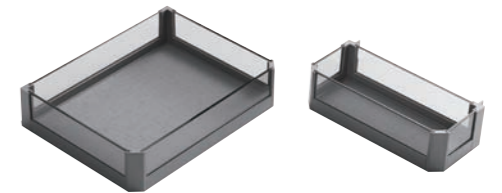
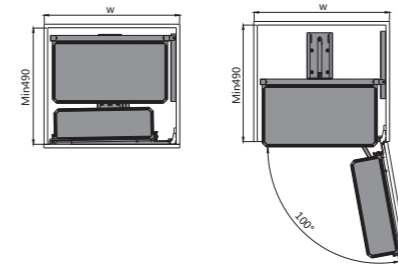

MODEL / 型号	CABINET / 柜体 W (mm)	WIDTH x DEPTH x HEIGHT (mm) 宽 x 深 x 高 (mm) . 含导轨	PACKAGING / 包装数量
WB1208S.045EG.DG	450	410x490x1710	1套 / 2箱 (6层)
WB1208S.060EG.DG	600	560x490x1710	1套 / 2箱 (6层)

Soft Closing Glass Swivel Pull-out Basket



魅影中柜联动拉篮



→ FEATURES / 产品特点

- Perfect connection between basket and door soft closing
拉篮与门板巧妙连接，联动开启，缓冲关闭
- Flat glass basket and heavy duty slide
玻璃防滑四层篮，重型滑轨
- Clear classification, more storage space, convenient and smooth operation
分类存储各种物品，存储量大，收取便利
- Color: Dark grey
颜色：深灰色



→ TECHNICAL DETAILS / 技术参数

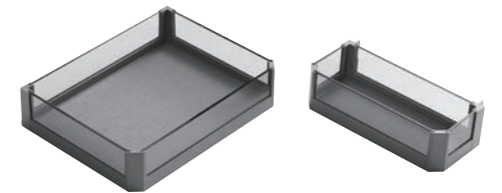
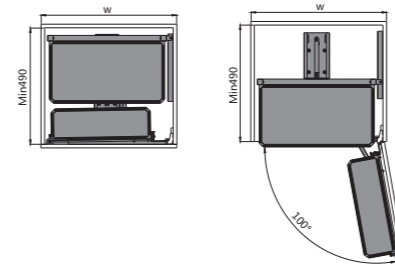

MODEL / 型号	CABINET / 柜体 W (mm)	WIDTH x DEPTH x HEIGHT (mm) 宽 x 深 x 高 (mm) . 含导轨	PACKAGING / 包装数量
WB1208S.045CG.DG	450	410x490x1110	1套 / 2箱 (4层)
WB1208S.060CG.DG	600	560x490x1110	1套 / 2箱 (4层)

Soft Closing Glass Swivel Pull-out Basket



魅影地柜联动拉篮



→ FEATURES / 产品特点

- Perfect connection between basket and door soft closing
拉篮与门板巧妙连接，联动开启，缓冲关闭
- Flat glass basket and heavy duty slide
玻璃防滑二层篮，重型滑轨
- Clear classification, more storage space, convenient and smooth operation
分类存储各种物品，存储量大，收取便利
- Color: Dark grey
颜色：深灰色



→ TECHNICAL DETAILS / 技术参数

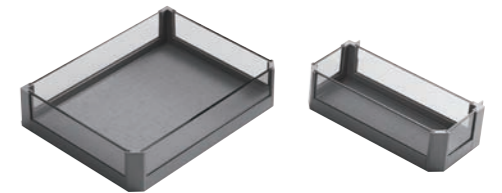
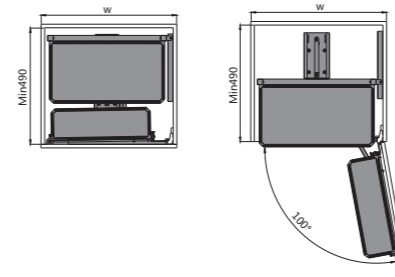

MODEL / 型号	CABINET / 柜体 W (mm)	WIDTH x DEPTH x HEIGHT (mm) 宽 x 深 x 高 (mm) . 含导轨	PACKAGING / 包装数量
WB1208S.045AG.DG	450	410x490x605	1套 / 箱 (2层)
WB1208S.060AG.DG	600	560x490x605	1套 / 箱 (2层)

GLASS SOFT CLOSING TALL UNIT BASKETS

魅影缓冲高深拉篮

HEAVY DUTY SLIDE - THE KEY TO REACHING THE SMOOTH OPENING AND CLOSING FOR TALL UNIT BASKET.

重型缓冲导轨技术也是实现高柜拉伸功能的关键，尤其在承重量达到相当程度的前提下，整体顺滑拉出时，重型缓冲技术都为使用者提供绝佳的功能保障，体现了支撑能力与收纳功能的完美平衡。



Glass Soft Closing Tall Unit Baskets



魅影缓冲高深拉篮



→ FEATURES / 产品特点

- Smooth and soft closing
抽拉顺畅，缓冲关闭
- Flat glass basket and heavy duty slide
玻璃防滑六层篮，重型缓冲滑轨
- Clear classification, more storage space, convenient and smooth operation
分类存储各种物品，存储量大，收取便利
- Color: Dark grey
颜色：深灰色



→ TECHNICAL DETAILS / 技术参数

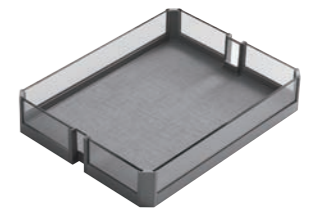
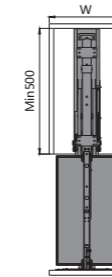

MODEL / 型号	CABINET / 柜体 W (mm)	WIDTH x DEPTH x HEIGHT (mm) 宽 x 深 x 高 (mm) . 含导轨	PACKAGING / 包装数量
WB1205S.015EG.DG	150	113x500x1970-2270	1套 / 3箱 (6层)
WB1205S.030EG.DG	300	245x500x1970-2270	1套 / 3箱 (6层)
WB1205S.040EG.DG	400	345x500x1970-2270	1套 / 3箱 (6层)

GLASS THREE SIDES BASKET

魅影三边拉篮

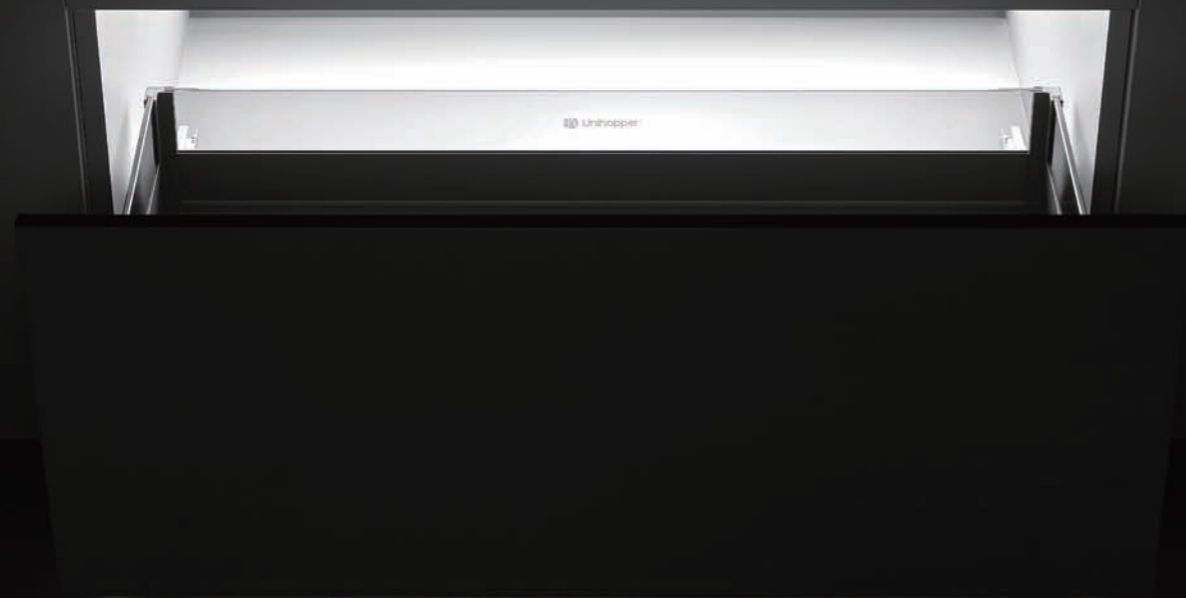

MULTI-FUNCTIONS MAKE YOUR KITCHEN MORE ELEGANT, CLEAN AND WELL-STORAGE.

丰富的功能让厨房生活更优雅。整洁高效的收纳功能，让您对所有物品一目了然，轻松高效的备餐。体验生活的最高舒适状态。



GLASS THREE SIDES BASKET

魅影三边碗碟拉篮

EACH KITCHEN STUFF HAS ITS OWN PLACE, SO YOU DON'T HAVE TO WORRY ABOUT HOW TO PUT IT. STAY EASY, STAY COMFORT.

专属区域，轻松整理。每种物品都有专属位置，不用费心研究怎么摆放，轻轻松松就能整齐收纳。省心省力，知你所需。







→ FEATURES / 产品特点

- Clip-on two way slow motion slides, 53mm soft closing distance
快装、双缓冲功能领先优势, 缓冲距离 53mm
- Glass three sides basket, synchronized conceal slide
玻璃三边篮, 收纳一目了然
- For pots, big plates and plastic holders etc
可存放各种锅类、大餐盘, 碗等
- Color: Dark grey
颜色: 深灰色



→ TECHNICAL DETAILS / 技术参数

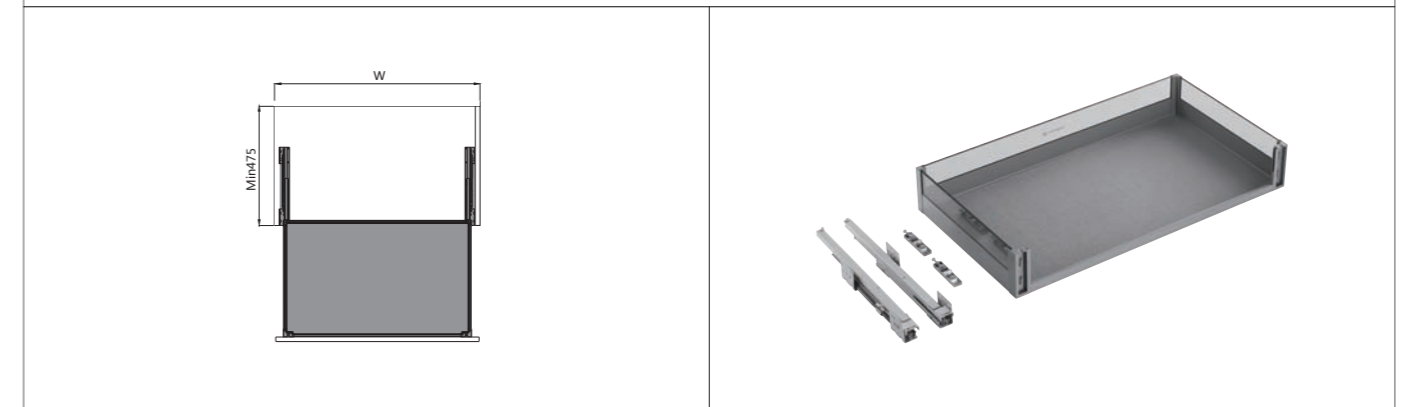

MODEL / 型号	CABINET / 柜体 W (mm)	WIDTH x DEPTH x HEIGHT (mm) 宽 x 深 x 高 (mm) . 含导轨	PACKAGING / 包装数量
WB2352S.060.DG	600	564x471x175	1套 / 箱
WB2352S.070.DG	700	664x471x175	1套 / 箱
WB2352S.075.DG	750	714x471x175	1套 / 箱
WB2352S.080.DG	800	764x471x175	1套 / 箱
WB2352S.090.DG	900	864x471x175	1套 / 箱



→ FEATURES / 产品特点

- Clip-on two way slow motion slides, 53mm soft closing distance
快装、双缓冲功能领先优势, 缓冲距离 53mm
- Glass three sides basket, synchronized conceal slide
玻璃三边碗碟篮, DIY 自由搭配, 收纳一目了然
- For pots, big plates and plastic holders etc
可存放各种锅类、大餐盘, 碗等
- Color: Dark grey
颜色: 深灰色



→ TECHNICAL DETAILS / 技术参数

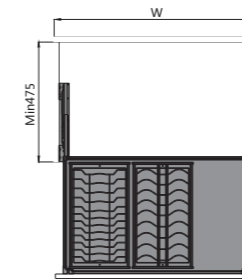

MODEL / 型号	CABINET / 柜体 W (mm)	WIDTH x DEPTH x HEIGHT (mm) 宽 x 深 x 高 (mm) . 含导轨	PACKAGING / 包装数量
WB2353S.060.DG	600	564x471x175	1 套 / 箱
WB2353S.070.DG	700	664x471x175	1 套 / 箱
WB2353S.075.DG	750	714x471x175	1 套 / 箱
WB2353S.080.DG	800	764x471x175	1 套 / 箱
WB2353S.090.DG	900	864x471x175	1 套 / 箱

GLASS MULTI-BASKET

魅影调味拉篮





THREE LAYERS DESIGN MAKE STORAGE MORE REASONABLE AND ORDERLY.
充分发掘收纳潜力，高低三层设计，轻松兼容不同高度物品，互不干涉井然有序，空间利用更合理。



GLASS SIDE MOUNTED BASKET

魅影侧装调味拉篮







→ FEATURES / 产品特点

- Clip-on two way slow motion slides, 53mm soft closing distance
快装、双缓冲功能领先优势, 缓冲距离 53mm
- Glass three sides basket, synchronized conceal slide
玻璃篮, 收纳一目了然, 多功能的空间分配
- For pots, big plates and plastic holders etc
可存放刀叉、筷子、饭勺等小餐具
- Color: Dark grey
颜色: 深灰色



→ TECHNICAL DETAILS / 技术参数

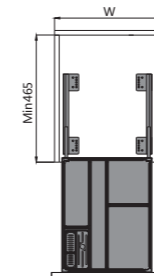

MODEL / 型号	CABINET / 柜体 W (mm)	WIDTH x DEPTH x HEIGHT (mm) 宽 x 深 x 高 (mm) . 含导轨	PACKAGING / 包装数量
WB2428S.030.DG	300	250x460x523	1套 / 箱
WB2428S.035.DG	350	300x460x523	1套 / 箱
WB2428S.040.DG	400	350x460x523	1套 / 箱
WB2428S.045.DG	450	400x460x523	1套 / 箱



→ FEATURES / 产品特点

- Clip-on two way slow motion slides, 53mm soft closing distance
快装、双缓冲功能领先优势，缓冲距离 53mm
- Clip-on two way slow motion slides, with side mounted glass basket
联动双缓冲骑马抽轨道，配合可自由拆装玻璃防滑挂篮
- Basket freely combination, left and right installation for choice, For all kinds of spice bottles
玻璃挂篮，挂篮可自由拆装，左、右两边安装选择，可存放各种调味瓶
- Color: Dark grey
颜色：深灰色



→ TECHNICAL DETAILS / 技术参数

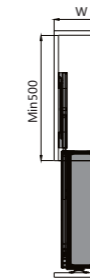

MODEL / 型号	CABINET / 柜体 W (mm)	WIDTH x DEPTH x HEIGHT (mm) 宽 x 深 x 高 (mm) . 含导轨	PACKAGING / 包装数量
WB2358SR.020.DG	200	152x490x585	1套 / 箱
WB2358SL.020.DG	200	152x490x585	1套 / 箱

GLASS MAGIC CORNER

魅影缓冲小怪物拉篮



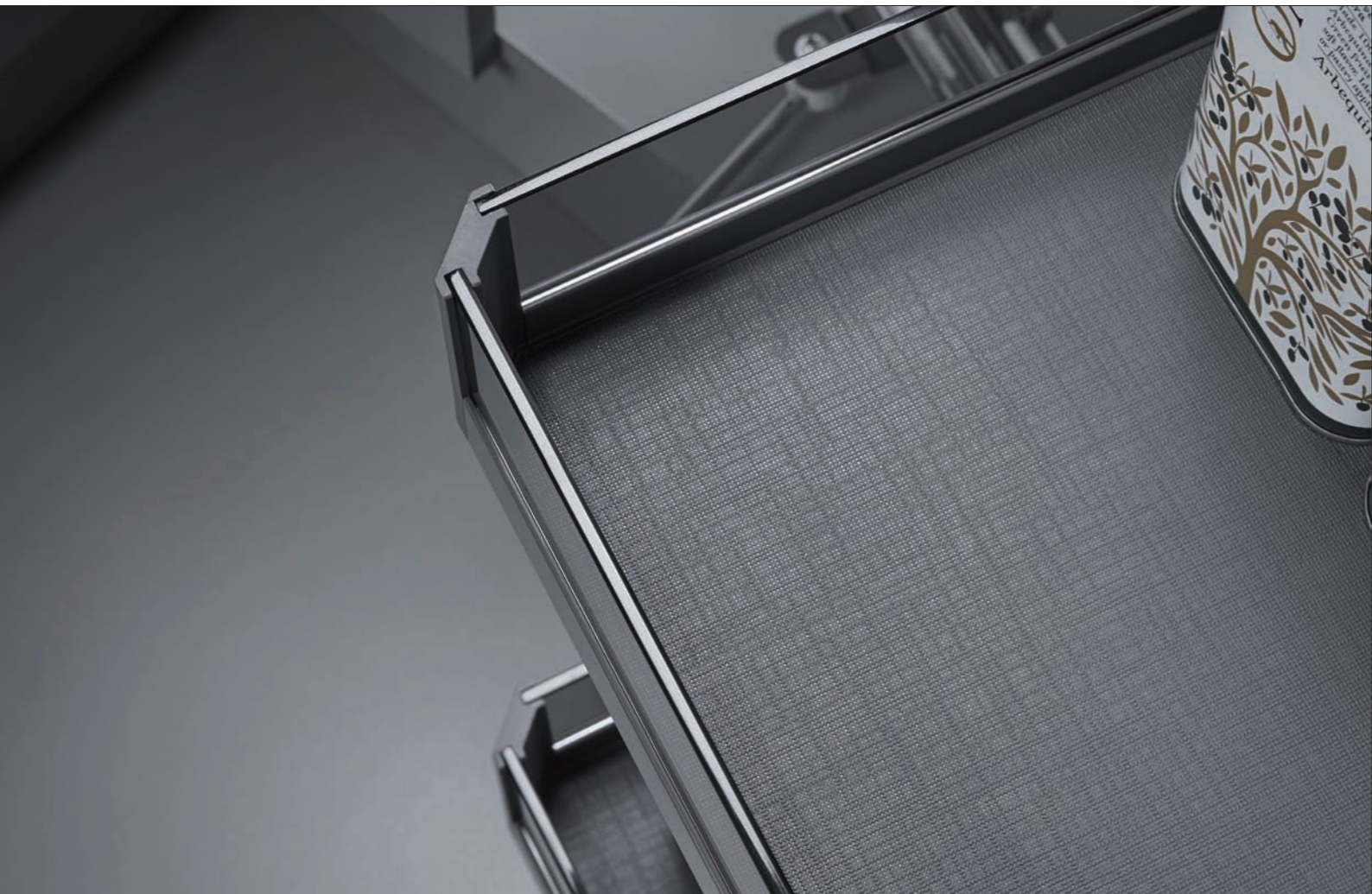

GLASS MAGIC CORNER, MAKE FULL USE OF THE CORNER SPACE, SYNCHRONIZED STRUCTURE WORKS SMOOTH OPENING AND CLOSING.

魅影缓冲小怪物，充分利橱柜转角空间，通过精巧设计得联动系统，实现轻松开合，只需轻拉柜门，就能轻松取物，让你从容享受品质生活。



→ FEATURES / 产品特点

- Soft closing; Make good use of corner space
Basket freely combination, left and right installation for choice
轻柔开启、缓冲关闭, 转角柜优化解决方案之一;
左、右两边开启方向选择
- For pots, big plates etc
可存放各种锅类、大餐盘, 收纳瓶罐等
- High strength steel frame, movable glass basket
高强度钢架结构, 可自由拆装玻璃防滑挂篮
- Color: Dark grey
颜色: 深灰色



→ TECHNICAL DETAILS / 技术参数

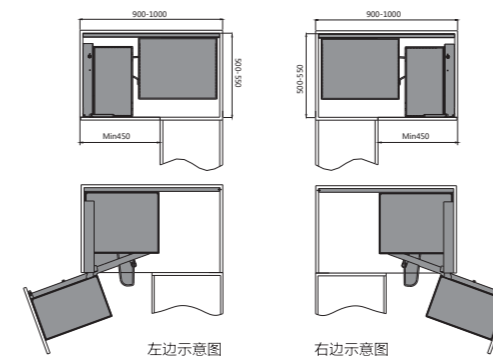

MODEL / 型号	CABINET / 柜体 W (mm)	WIDTH x DEPTH x HEIGHT (mm) 宽 x 深 x 高 (mm) . 含导轨	PACKAGING / 包装数量
WB2106SR.090G.DG	900	860-968x500-550x530	1套 / 箱
WB2106SL.090G.DG	900	860-968x500-550x530	1套 / 箱

GLASS LIFT BASKET

魅影升降吊柜篮

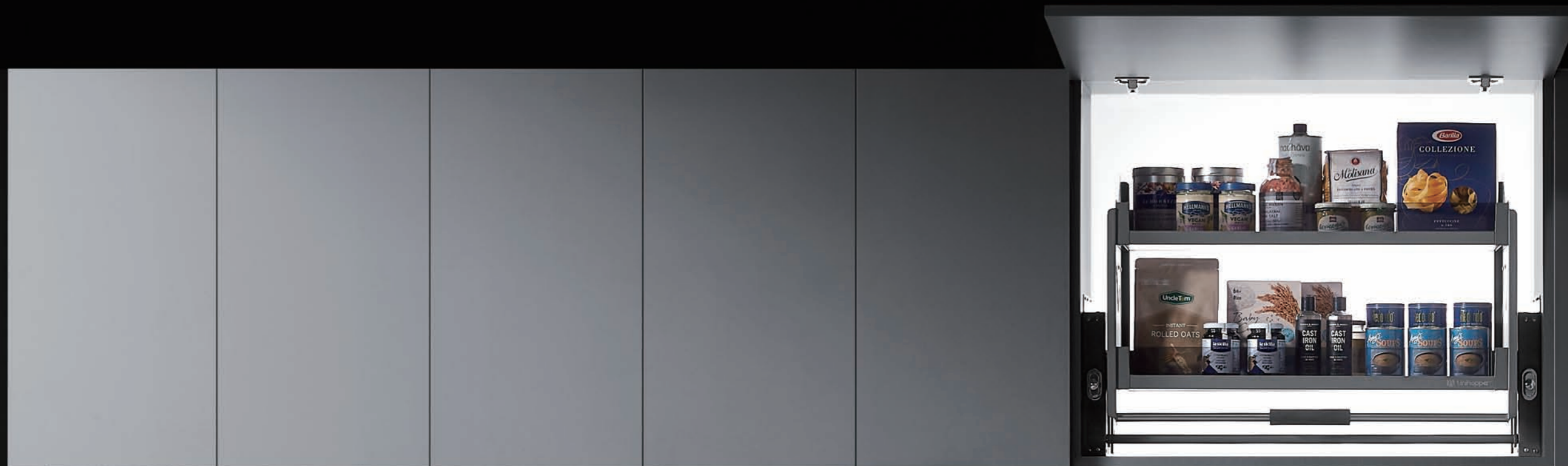

UP-DOWN DESIGN, TO MAKE FULL USE OF SPACE FOR THE WALL CUPBOARD.
 ABLE TO ADJUST THE PULLING CAPACITY, SAFE FOR TAKING OR BRINGING THINGS.

可升降设计，让吊柜空间利用变得平易近人。人性化设计，可根据储物重量调节下拉力和或弹力，让上下取物更安全。

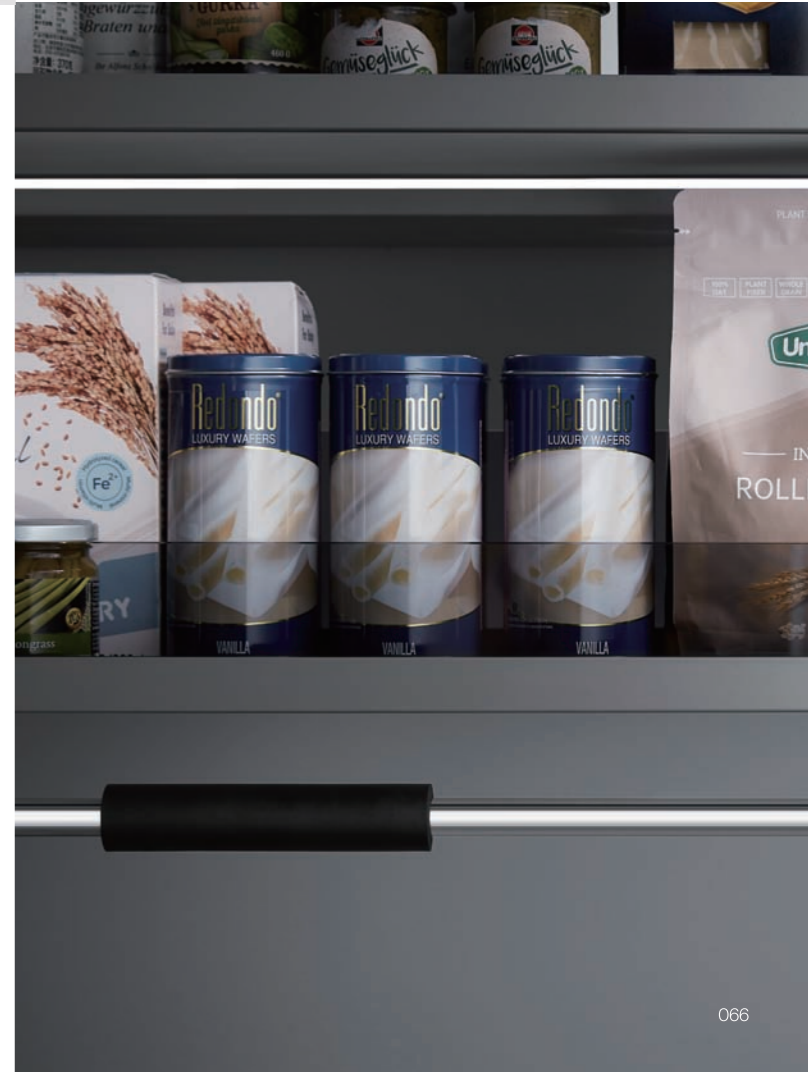



→ FEATURES / 产品特点

- Soft opening, soft closing, adjustable loading capacity, Reasonable use the space of wall cupboard
轻柔开启、缓冲关闭，三种载重可调，可以把吊柜空间巧妙转化为活动空间；吊柜优化解决方案之一
- Strong frame, two layers glass basket
高强度钢架结构，两层玻璃防滴篮
- Pans, big plates...
可存放各种锅类、大餐盘，收纳瓶罐等
- Color: Dark grey
颜色：深灰色



→ TECHNICAL DETAILS / 技术参数

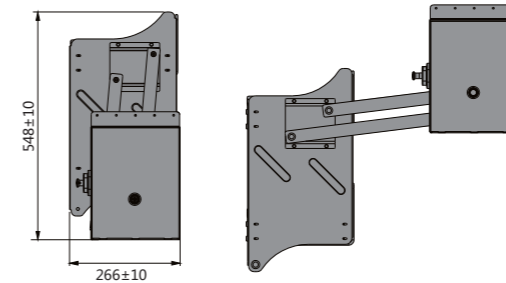

MODEL / 型号	CABINET / 柜体 W (mm)	WIDTH x DEPTH x HEIGHT (mm) 宽 x 深 x 高 (mm) . 含导轨	PACKAGING / 包装数量
WB3303S.060.DG	600	560x280x560	1套 / 箱
WB3303S.070.DG	700	660x280x560	1套 / 箱
WB3303S.080.DG	800	760x280x560	1套 / 箱
WB3303S.090.DG	900	860x280x560	1套 / 箱

LINA STORAGE SYSTEM

丽影系列







THREE SIDES BASKET

丽影三边拉篮



THREE SIDES BASKET

丽影三边碗碟拉篮



TREND-SETTING AND MODULAR DESIGN WITH MULTI-PURPOSE, AND SPACE-EFFICIENT, BE A MAGIC BASKET FOR KITCHEN.
 多种用途，模块化设计，小空间大智慧，使用更方便。打破传统拉篮的设计局限，功能齐全，收纳精细，不仅仅是拉篮，更是厨房百宝箱。





Three Sides Basket



丽影三边平网拉篮



→ FEATURES / 产品特点

- Clip-on two way slow motion slides, 53mm soft closing distance
快装、双缓冲功能领先优势，缓冲距离 53mm
- For pots, big plates and plastic holders etc
可存放各种锅类、大餐盘、碗等
- Big space for your different cookers
平铺直放空间更大，满足不同的收纳需求
- Color: Nano dark grey
颜色：纳米炭灰色



→ TECHNICAL DETAILS / 技术参数

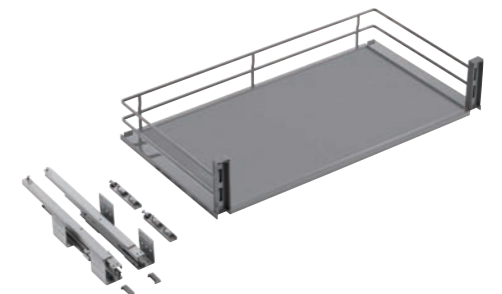
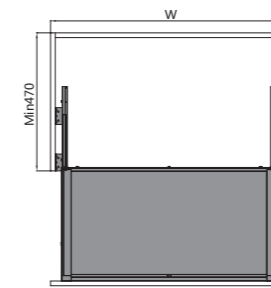

MODEL / 型号	CABINET / 柜体 W (mm)	WIDTH x DEPTH x HEIGHT (mm) 宽 x 深 x 高 (mm) . 含导轨	PACKAGING / 包装数量
WB2382S.060.NDG	600	564x435x185	1套 / 箱
WB2382S.070.NDG	700	664x435x185	1套 / 箱
WB2382S.075.NDG	750	714x435x185	1套 / 箱
WB2382S.080.NDG	800	764x435x185	1套 / 箱
WB2382S.090.NDG	900	864x435x185	1套 / 箱

Three Sides Basket



丽影三边碗碟拉篮



→ FEATURES / 产品特点

- Clip-on two way slow motion slides, 53mm soft closing distance
快装、双缓冲功能领先优势，缓冲距离 53mm
- Plastic tray + Individual dish rack, convenience for your daily use
接水盘 + 分离餐具格，打造立体便捷可变收纳体验
- Store all kinds of knives and forks, chopsticks, spoons, dishes, etc
可存放各种刀叉、筷子、勺子、碗碟等
- Color: Nano dark grey
颜色：纳米炭灰色



→ TECHNICAL DETAILS / 技术参数

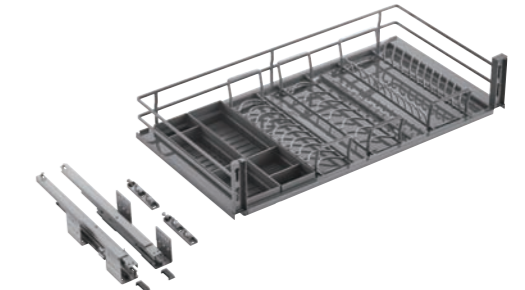
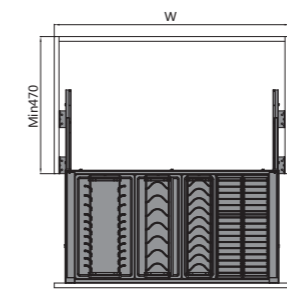

MODEL / 型号	CABINET / 柜体 W (mm)	WIDTH x DEPTH x HEIGHT (mm) 宽 x 深 x 高 (mm) . 含导轨	PACKAGING / 包装数量
WB2383S.060.NDG	600	564x435x185	1 套 / 箱
WB2383S.070.NDG	700	664x435x185	1 套 / 箱
WB2383S.075.NDG	750	714x435x185	1 套 / 箱
WB2383S.080.NDG	800	764x435x185	1 套 / 箱
WB2383S.090.NDG	900	864x435x185	1 套 / 箱

MULTI-BASKET

丽影调味拉篮



EXPERIENCE MORE OF LIFE WITH THE DELICATE AND MULTIFUNCTIONAL DESIGN.
用好的设计规划空间，为生活展开更多可能。小小空间，大大功能，给您巧妙的空间陈列，轻松找到您想要的。



MULTI-BASKET STORAGE ALL KINDS OF KITCHEN SEASONINGS, EXPLOIT THE SIMPLICITY AND TIDY IN SMALL SPACE.

简洁大方，方寸之间均物尽其用，彰显空间大师的独特魅力。秉承合理分区储物的理念，无论大容量食用油，还是调味品等，均能找到合适的存放位置。





→ FEATURES / 产品特点

- Clip-on two way slow motion slides, 53mm soft closing distance
快装、双缓冲功能领先优势, 缓冲距离 53mm
- Store knives and forks, chopsticks, spoons, seasoning pots, etc
可存放调味品、刀叉、筷子、饭勺等小餐具
- Kitchenware are in good order with dish rack
收纳一目了然, 多功能可调节空间分配
- Color: Nano dark grey
颜色: 纳米炭灰色



→ TECHNICAL DETAILS / 技术参数

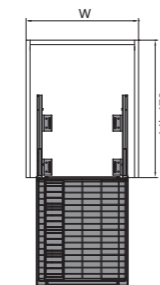

MODEL / 型号	CABINET / 柜体 W (mm)	WIDTH x DEPTH x HEIGHT (mm) 宽 x 深 x 高 (mm) . 含导轨	PACKAGING / 包装数量
WB2437S.030.NDG	300	218x440x524	1套 / 箱
WB2437S.035.NDG	350	268x440x524	1套 / 箱
WB2437S.040.NDG	400	318x440x524	1套 / 箱
WB2437S.045.NDG	450	368x440x524	1套 / 箱

VINA STORAGE SYSTEM

慧影系列



WINA
慧影拉篮

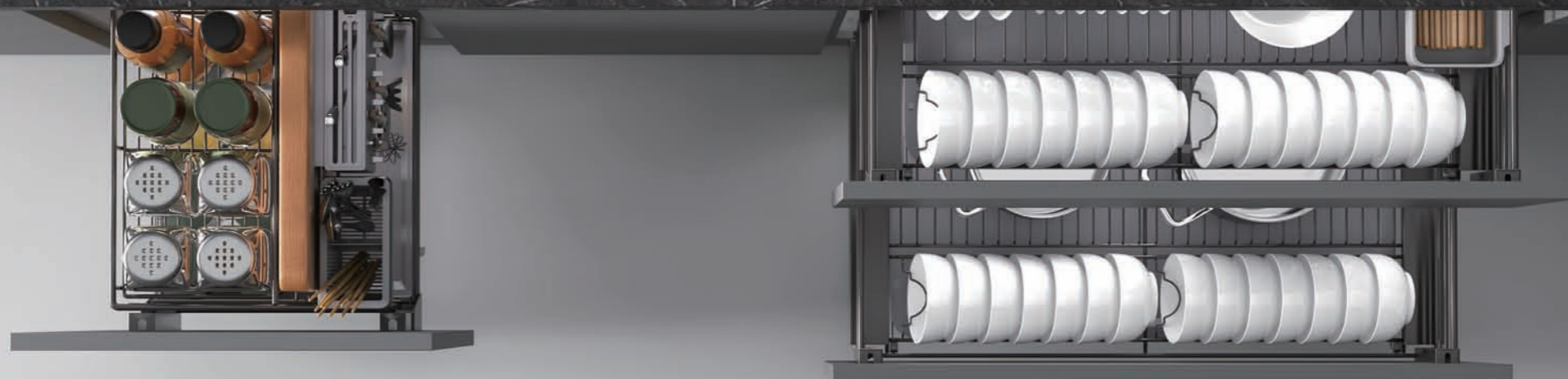

Three Sides Plain Basket

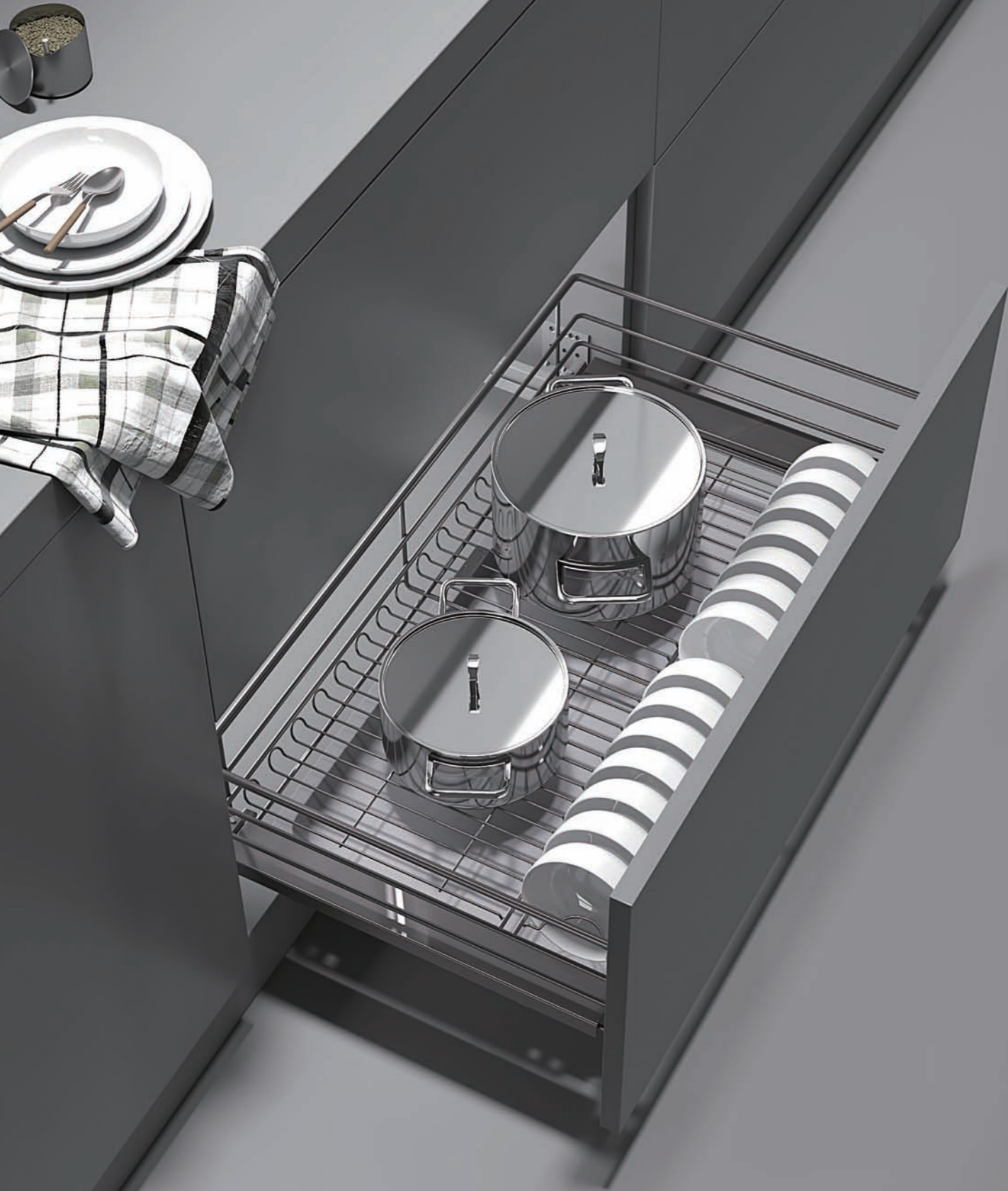

慧影三边平网拉篮



→ FEATURES / 产品特点

- Clip-on two way slow motion slides, 53mm soft closing distance
快装、双缓冲功能领先优势，缓冲距离 53mm
- Glass three sides basket, synchronized concealed slide
绿色环保，纳米科技，极强耐腐蚀和抗氧化
- For pots, big plates and plastic holders etc
可存放各种锅类、大餐盘、碗等
- Color: Nano dark grey
颜色：纳米炭灰色

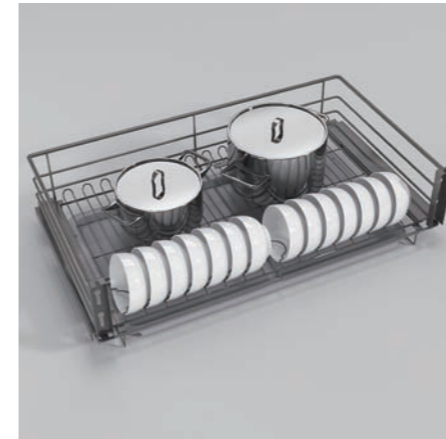

→ TECHNICAL DETAILS / 技术参数

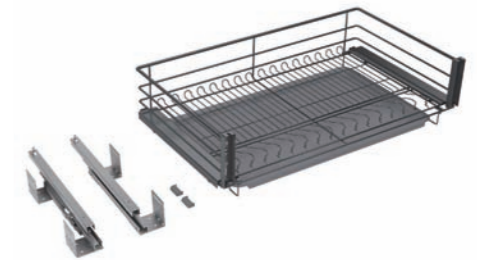
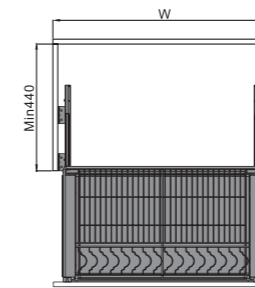

MODEL / 型号	CABINET / 柜体 W (mm)	WIDTH x DEPTH x HEIGHT (mm) 宽 x 深 x 高 (mm) . 含导轨	PACKAGING / 包装数量
WB2388S.060.NDG	600	564x431x203	1套 / 箱
WB2388S.070.NDG	700	664x431x203	1套 / 箱
WB2388S.075.NDG	750	714x431x203	1套 / 箱
WB2388S.080.NDG	800	764x431x203	1套 / 箱
WB2388S.090.NDG	900	864x431x203	1套 / 箱

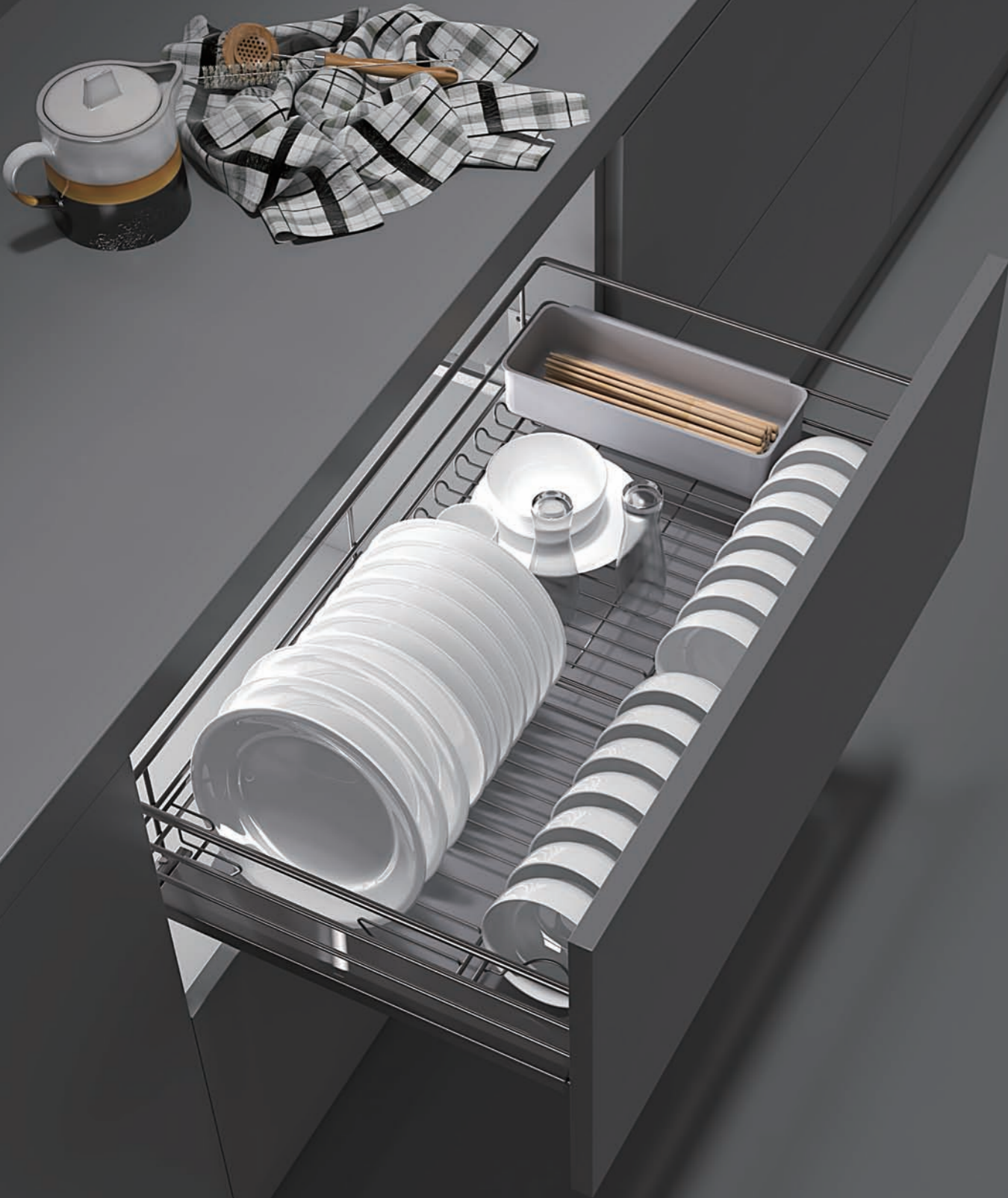

→ FEATURES / 产品特点

- Clip-on two way slow motion slides, 53mm soft closing distance
快装、双缓冲功能领先优势，缓冲距离 53mm
- Glass three sides basket, synchronized conceal slide
绿色环保，纳米科技，极强耐腐蚀和抗氧化
- For pots, big plates and plastic holders etc
多功能碗碟分区存放；碗碟存放科学合理、取储方便
- Color: Nano dark grey
颜色：纳米炭灰色

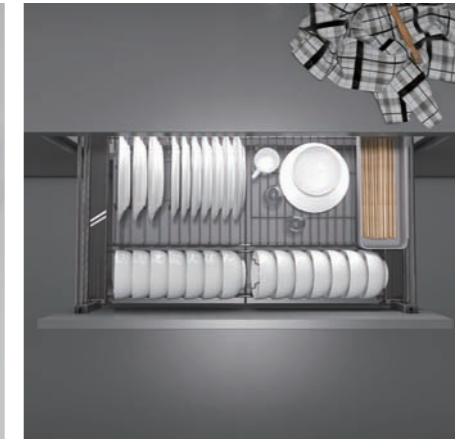

→ TECHNICAL DETAILS / 技术参数

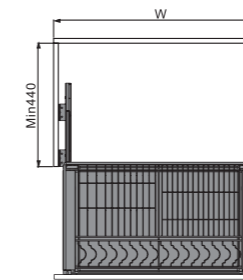

MODEL / 型号	CABINET / 柜体 W (mm)	WIDTH x DEPTH x HEIGHT (mm) 宽 x 深 x 高 (mm) . 含导轨	PACKAGING / 包装数量
WB2389S.060.NDG	600	564x431x203	1套 / 箱
WB2389S.070.NDG	700	664x431x203	1套 / 箱
WB2389S.075.NDG	750	714x431x203	1套 / 箱
WB2389S.080.NDG	800	764x431x203	1套 / 箱
WB2389S.090.NDG	900	864x431x203	1套 / 箱



慧影调味拉篮



→ FEATURES / 产品特点

- Clip-on two way slow motion slides, 53mm soft closing distance
快装、双缓冲功能领先优势，缓冲距离 53mm
- Clip-on two way slow motion slides, with glass multi-basket
联动双缓冲骑马抽轨道，配合环保纳米干镀膜调味拉篮
- For pots, big plates and plastic holders etc
可存放刀叉、筷子、饭勺等小餐具
- Color: Nano dark grey
颜色：纳米炭灰色



→ TECHNICAL DETAILS / 技术参数

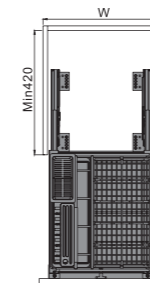

MODEL / 型号	CABINET / 柜体 W (mm)	WIDTH x DEPTH x HEIGHT (mm) 宽 x 深 x 高 (mm) . 含导轨	PACKAGING / 包装数量
WB2439S.030.NDG	300	240x412x475	1套 / 箱
WB2439S.035.NDG	350	290x412x475	1套 / 箱
WB2439S.040.NDG	400	340x412x475	1套 / 箱
WB2439S.045.NDG	450	390x412x475	1套 / 箱

NANO STORAGE SYSTEM

纳米系列



SOFT CLOSING SWIVEL PULL-OUT BASKET

纳米缓冲板式高柜联动拉篮



SOFT CLOSING TALL UNIT BASKET PERFECTLY COMBINED FUNCTIONALITY AND DAILY PRACTICALITY. FIT FOR ALL KINDS OF ITEMS IN KITCHEN.

高柜系统将功能与日常实用性完美地融合在一起，通过融合各种矛盾，创造出真正的非凡之作：一款适合厨房收纳各种物品的性能强大的功能五金。

Soft Closing Swivel Pull-out Basket



纳米缓冲板式高柜联动拉篮



→ FEATURES / 产品特点

- Perfect connection between basket and door soft closing
拉篮与门板巧妙连接，联动开启，缓冲关闭
- Flat steel basket and heavy duty slide
纳米板式防滑六层篮，重型缓冲滑轨
- Clear classification, more storage space, convenient and smooth operation
分类存储各种物品，存储量大，收取便利
- Color: Dark grey
颜色：深灰色



→ TECHNICAL DETAILS / 技术参数

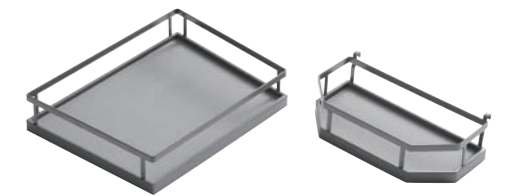
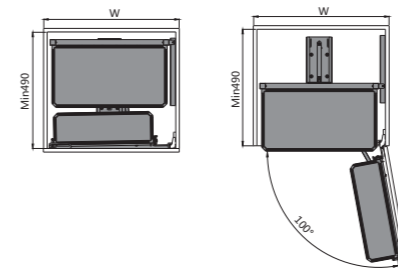

MODEL / 型号	CABINET / 柜体 W (mm)	WIDTH x DEPTH x HEIGHT (mm) 宽 x 深 x 高 (mm) . 含导轨	PACKAGING / 包装数量
WB1208S.045EW.DG	450	410x490x1710	1套 / 2箱 (6层)
WB1208S.060EW.DG	600	560x490x1710	1套 / 2箱 (6层)

Soft Closing Swivel Pull-out Basket



纳米缓冲板式中柜联动拉篮



→ FEATURES / 产品特点

- Perfect connection between basket and door soft closing
拉篮与门板巧妙连接，联动开启，缓冲关闭
- Flat steel basket and heavy duty slide
纳米板式防滑四层篮，重型缓冲滑轨
- Clear classification, more storage space, convenient and smooth operation
分类存储各种物品，存储量大，收取便利
- Color: Dark grey
颜色：深灰色

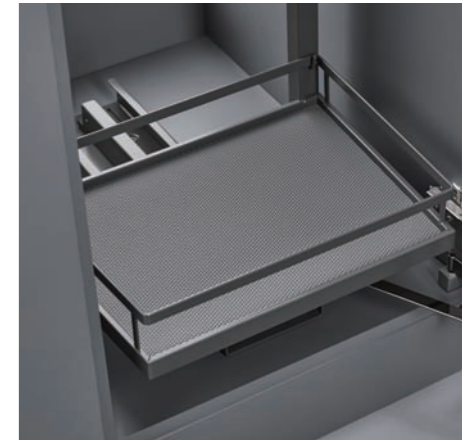

→ TECHNICAL DETAILS / 技术参数

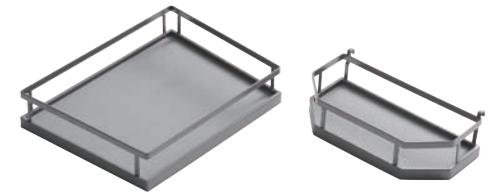
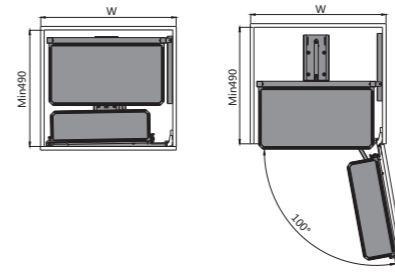

MODEL / 型号	CABINET / 柜体 W (mm)	WIDTH x DEPTH x HEIGHT (mm) 宽 x 深 x 高 (mm) . 含导轨	PACKAGING / 包装数量
WB1208S.045CW.DG	450	410x490x1110	1套 / 2箱 (4层)
WB1208S.060CW.DG	600	560x490x1110	1套 / 2箱 (4层)

Soft Closing Swivel Pull-out Basket



纳米缓冲板式地柜联动拉篮



→ FEATURES / 产品特点

- Perfect connection between basket and door soft closing
拉篮与门板巧妙连接，联动开启，缓冲关闭
- Flat steel basket and heavy duty slide
纳米板式防滑二层篮，重型缓冲滑轨
- Clear classification, more storage space, convenient and smooth operation
分类存储各种物品，存储量大，收取便利
- Color: Dark grey
颜色：深灰色

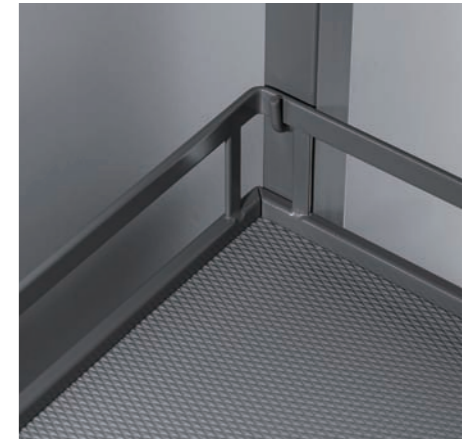

→ TECHNICAL DETAILS / 技术参数

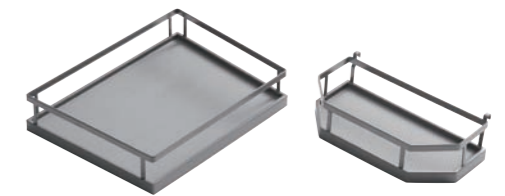
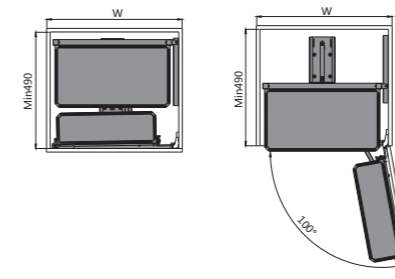

MODEL / 型号	CABINET / 柜体 W (mm)	WIDTH x DEPTH x HEIGHT (mm) 宽 x 深 x 高 (mm) . 含导轨	PACKAGING / 包装数量
WB1208S.045AW.DG	450	410x490x605	1套 / 箱 (2层)
WB1208S.060AW.DG	600	560x490x605	1套 / 箱 (2层)



SOFT CLOSING TALL UNIT BASKETS

纳米板式缓冲高深拉篮

TRENDY DESIGN, EXQUISITE CRAFT, AND PRACTICAL FUNCTION,
PROVIDE A HIGH-QUALITY LIFE.

时尚的艺术设计，不断演进的制作工艺与潜藏的实质功能，深化家居艺术，升华人居生活品质，
只钟情于懂得享受生活的您。

EVERY MOVEMENT REPRESENTS A QUALITY-OF-LIFE AND ATTITUDE.

每一次滑动构建一道生活风景线，收敛了锋芒，多了一份沉稳。它代表着一种生活的品质与态度。



Soft Closing Tall Unit Baskets



纳米板式缓冲高深拉篮



→ FEATURES / 产品特点

- Smooth and soft closing
抽拉顺畅，缓冲关闭
- Flat steel basket and heavy duty slide
纳米板式防滑六层篮，重型缓冲滑轨
- Clear classification, more storage space, convenient and smooth operation
分类存储各种物品，存储量大，收取便利
- Color: Dark grey
颜色：深灰色



→ TECHNICAL DETAILS / 技术参数

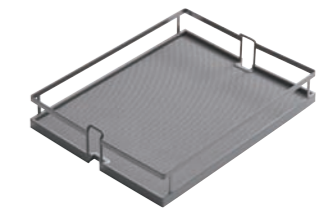
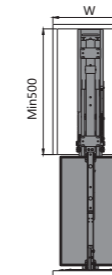

MODEL / 型号	CABINET / 柜体 W (mm)	WIDTH x DEPTH x HEIGHT (mm) 宽 x 深 x 高 (mm) . 含导轨	PACKAGING / 包装数量
WB1205S.015EW.DG	150	113x500x1970-2270	1套 / 2箱 (6层)
WB1205S.030EW.DG	300	245x500x1970-2270	1套 / 2箱 (6层)
WB1205S.040EW.DG	400	345x500x1970-2270	1套 / 2箱 (6层)

THREE SIDES PLAIN BASKET

纳米三边平网拉篮



THREE SIDES DISH RACK

纳米三边碗碟拉篮



Three Sides Plain Basket

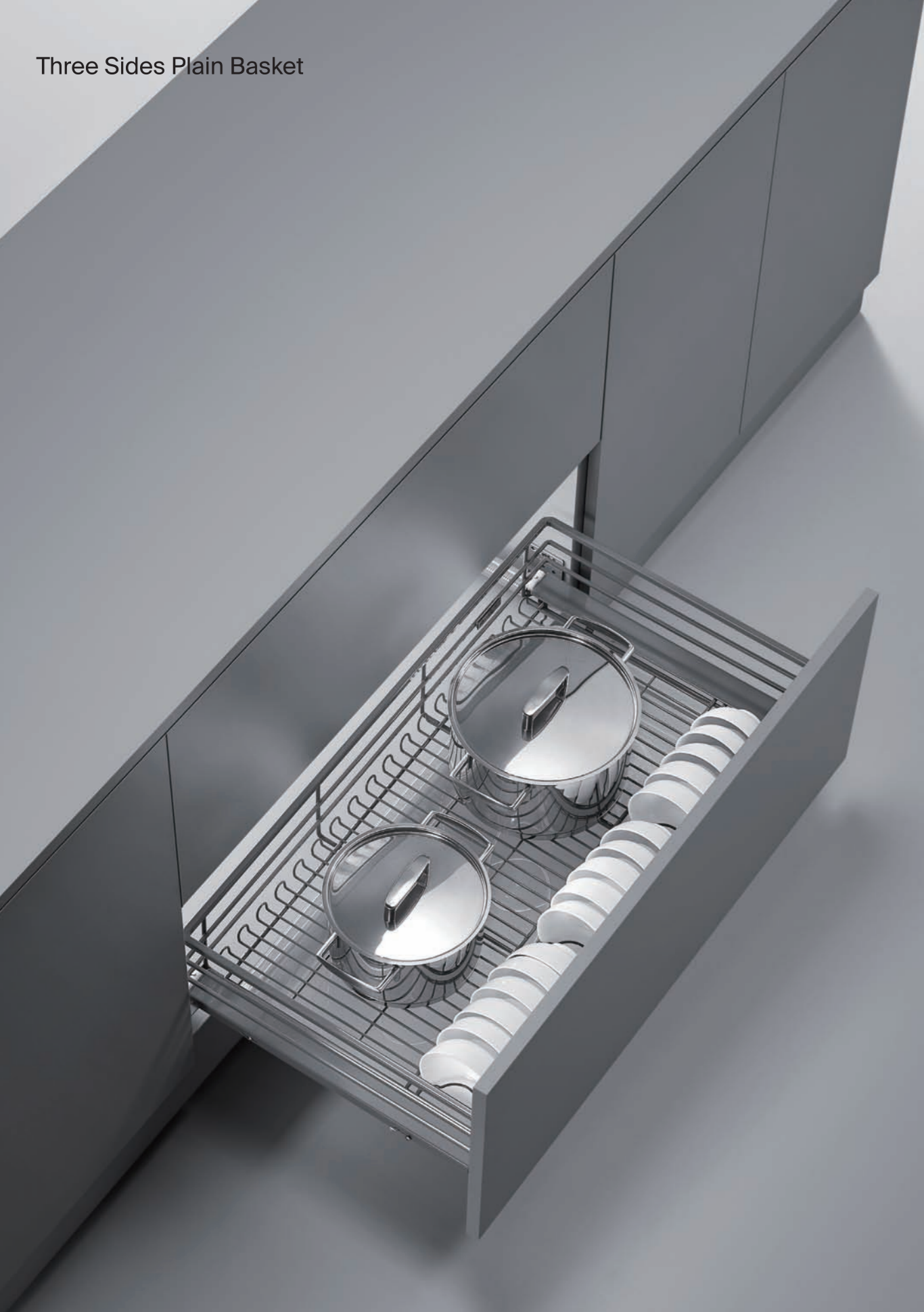

纳米三边平网拉篮



→ FEATURES / 产品特点

- Clip-on two way slow motion slides, 53mm soft closing distance
快装、双缓冲功能领先优势, 缓冲距离 53mm
- Glass three sides basket, synchronized concealed slide
绿色环保, 纳米科技, 极强耐腐蚀和抗氧化
- For pots, big plates and plastic holders etc
可存放各种锅类、大餐盘, 碗等
- Color: Nano dark grey
颜色: 纳米炭灰色



→ TECHNICAL DETAILS / 技术参数

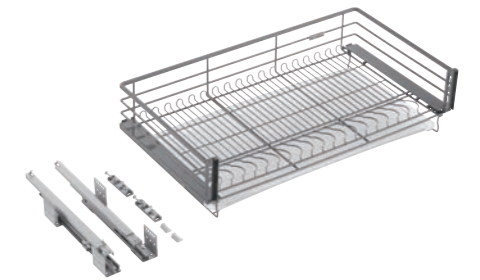
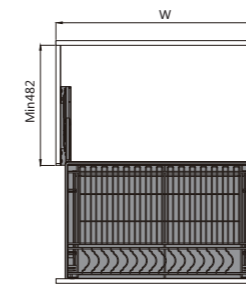

MODEL / 型号	CABINET / 柜体 W (mm)	WIDTH x DEPTH x HEIGHT (mm) 宽 x 深 x 高 (mm) . 含导轨	PACKAGING / 包装数量
WB2333S.060.NDG	600	564x475x175	1套 / 箱
WB2333S.070.NDG	700	664x475x175	1套 / 箱
WB2333S.075.NDG	750	714x475x175	1套 / 箱
WB2333S.080.NDG	800	764x475x175	1套 / 箱
WB2333S.090.NDG	900	864x475x175	1套 / 箱

Three Sides Dish Rack



纳米三边碗碟拉篮



→ FEATURES / 产品特点

- Clip-on two way slow motion slides, 53mm soft closing distance
快装、双缓冲功能领先优势，缓冲距离 53mm
- Glass three sides basket, synchronized conceal slide
绿色环保，纳米科技，极强耐腐蚀和抗氧化
- For pots, big plates and plastic holders etc
多功能碗碟分区存放；碗碟存放科学合理、取储方便
- Color: Nano dark grey
颜色：纳米炭灰色



→ TECHNICAL DETAILS / 技术参数

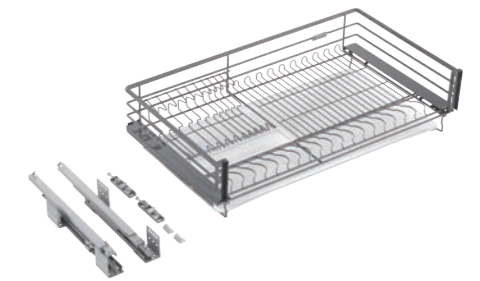
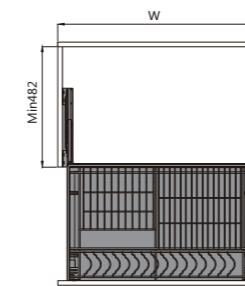

MODEL / 型号	CABINET / 柜体 W (mm)	WIDTH x DEPTH x HEIGHT (mm) 宽 x 深 x 高 (mm) . 含导轨	PACKAGING / 包装数量
WB2334S.060.NDG	600	564x475x195	1套 / 箱
WB2334S.070.NDG	700	664x475x195	1套 / 箱
WB2334S.075.NDG	750	714x475x195	1套 / 箱
WB2334S.080.NDG	800	764x475x195	1套 / 箱
WB2334S.090.NDG	900	864x475x195	1套 / 箱

Three Sides Plain Basket



畅销款纳米三边平网拉篮



→ FEATURES / 产品特点

- Clip-on two way slow motion slides, 53mm soft closing distance
双缓冲功能领先优势, 缓冲距离 53mm
- Glass three sides basket, synchronized conceal slide
绿色环保, 纳米科技, 极强耐腐蚀和抗氧化
- For pots, big plates and plastic holders etc
可存放各种锅类、大餐盘, 碗等
- Color: Dark grey
颜色: 深灰色



→ TECHNICAL DETAILS / 技术参数

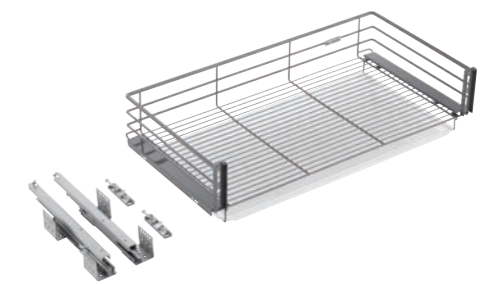
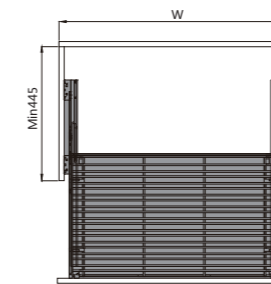

MODEL / 型号	CABINET / 柜体 W (mm)	WIDTH x DEPTH x HEIGHT (mm) 宽 x 深 x 高 (mm) . 含导轨	PACKAGING / 包装数量
WB2354S.060.DG	600	564x440x190	1套 / 箱
WB2354S.070.DG	700	664x440x190	1套 / 箱
WB2354S.075.DG	750	714x440x190	1套 / 箱
WB2354S.080.DG	800	764x440x190	1套 / 箱
WB2354S.090.DG	900	864x440x190	1套 / 箱

Three Sides Dish Rack



畅销款纳米三边碗碟拉篮



→ FEATURES / 产品特点

- Clip-on two way slow motion slides, 53mm soft closing distance
双缓冲功能领先优势, 缓冲距离 53mm
- Glass three sides basket, synchronized conceal slide
绿色环保, 纳米科技, 极强耐腐蚀和抗氧化
- For pots, big plates and plastic holders etc
多功能碗碟分区存放; 碗碟存放科学合理、取储方便
- Color: Dark grey
颜色: 深灰色



→ TECHNICAL DETAILS / 技术参数

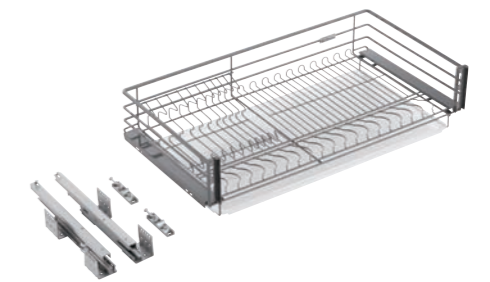
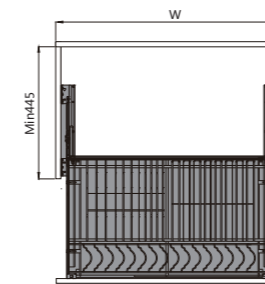

MODEL / 型号	CABINET / 柜体 W (mm)	WIDTH x DEPTH x HEIGHT (mm) 宽 x 深 x 高 (mm) . 含导轨	PACKAGING / 包装数量
WB2355S.060.DG	600	564x440x190	1套 / 箱
WB2355S.070.DG	700	664x440x190	1套 / 箱
WB2355S.075.DG	750	714x440x190	1套 / 箱
WB2355S.080.DG	800	764x440x190	1套 / 箱
WB2355S.090.DG	900	864x440x190	1套 / 箱

Four Sides Plain Basket

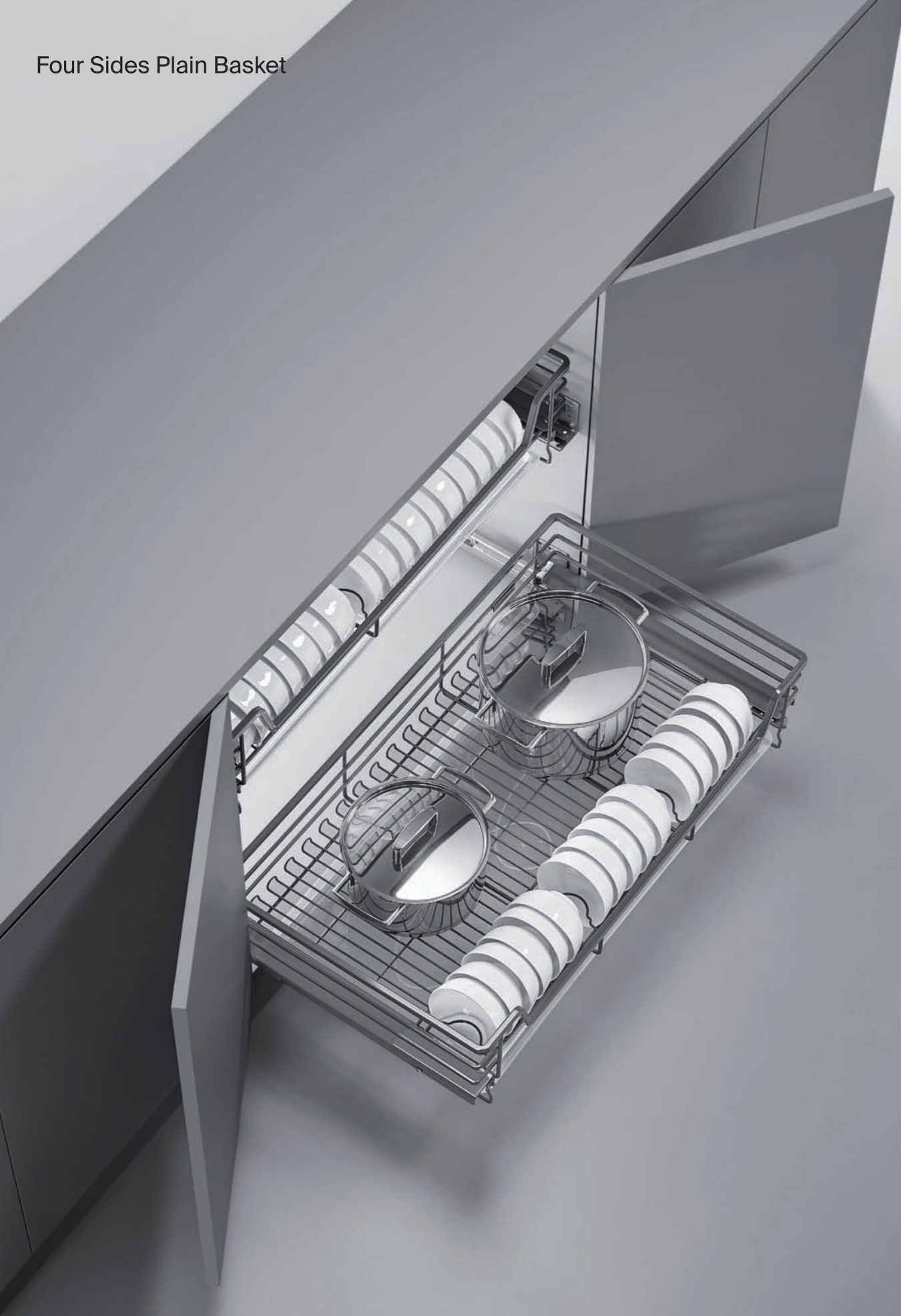

纳米四边平网拉篮



→ FEATURES / 产品特点

- Clip-on two way slow motion slides, 53mm soft closing distance
快装、双缓冲功能领先优势, 缓冲距离 53mm
- Glass three sides basket, synchronized concealed slide
绿色环保, 纳米科技, 极强耐腐蚀和抗氧化
- For pots, big plates and plastic holders etc
可存放各种锅类、大餐盘, 碗等
- Color: Nano dark grey
颜色: 纳米炭灰色



→ TECHNICAL DETAILS / 技术参数

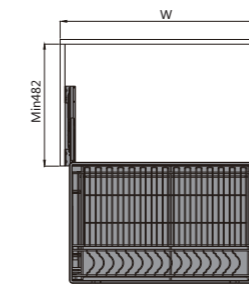

MODEL / 型号	CABINET / 柜体 W (mm)	WIDTH x DEPTH x HEIGHT (mm) 宽 x 深 x 高 (mm) . 含导轨	PACKAGING / 包装数量
WB2336S.060.NDG	600	564x475x175	1套 / 箱
WB2336S.070.NDG	700	664x475x175	1套 / 箱
WB2336S.075.NDG	750	714x475x175	1套 / 箱
WB2336S.080.NDG	800	764x475x175	1套 / 箱
WB2336S.090.NDG	900	864x475x175	1套 / 箱

Four Sides Plain Basket

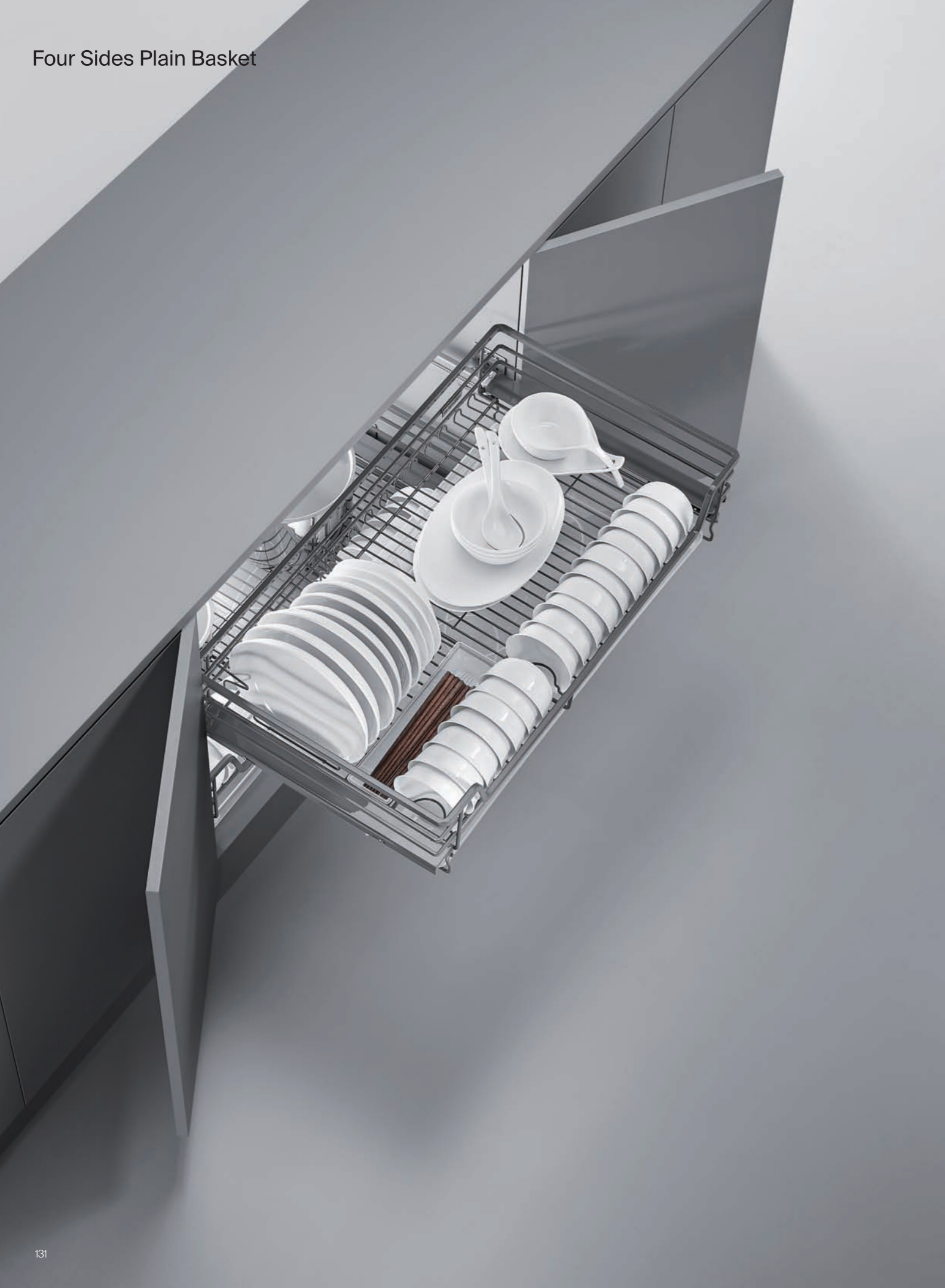

纳米四边碗碟拉篮



→ FEATURES / 产品特点

- Clip-on two way slow motion slides, 53mm soft closing distance
快装、双缓冲功能领先优势, 缓冲距离 53mm
- Glass three sides basket, synchronized conceal slide
绿色环保, 纳米科技, 极强耐腐蚀和抗氧化
- For pots, big plates and plastic holders etc
可存放各种锅类、大餐盘, 碗等
- Color: Nano dark grey
颜色: 纳米炭灰色



→ TECHNICAL DETAILS / 技术参数

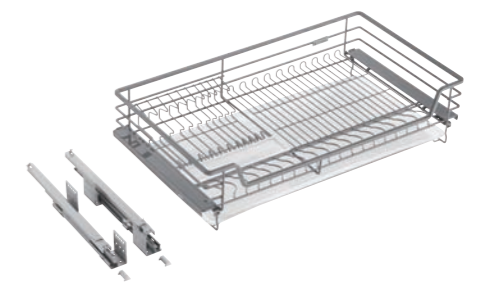
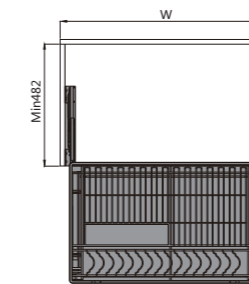

MODEL / 型号	CABINET / 柜体 W (mm)	WIDTH x DEPTH x HEIGHT (mm) 宽 x 深 x 高 (mm) . 含导轨	PACKAGING / 包装数量
WB2337S.060.NDG	600	564x475x175	1套 / 箱
WB2337S.070.NDG	700	664x475x175	1套 / 箱
WB2337S.075.NDG	750	714x475x175	1套 / 箱
WB2337S.080.NDG	800	764x475x175	1套 / 箱
WB2337S.090.NDG	900	864x475x175	1套 / 箱

MULTI-BASKET

纳米调味拉篮

THE COMBINATION OF ELEGANCE AND PRACTICALITY REFLECTS YOUR LIFE ATTITUDE.

高雅与实用的结合，在功能和美学之间寻求一种平衡，精巧别致的简洁造型体现了有棱有角的生活态度，优质的产品，贴心的设计，舒适尽享。





→ FEATURES / 产品特点

- Clip-on two way slow motion slides, 53mm soft closing distance
快装、双缓冲功能领先优势，缓冲距离 53mm
- Clip-on two way slow motion slides, with glass multi-basket
联动双缓冲骑马抽轨道，配合环保纳米干镀膜调味拉篮
- For pots, big plates and plastic holders etc
可存放刀叉、筷子、饭勺等小餐具
- Color: Nano dark grey
颜色：纳米炭灰色



→ TECHNICAL DETAILS / 技术参数

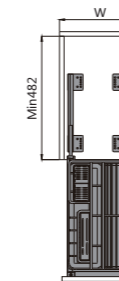

MODEL / 型号	CABINET / 柜体 W (mm)	WIDTH x DEPTH x HEIGHT (mm) 宽 x 深 x 高 (mm) . 含导轨	PACKAGING / 包装数量
WB2423S.030.NDG	300	245x475x490	1套 / 箱
WB2423S.035.NDG	350	295x475x490	1套 / 箱
WB2423S.040.NDG	400	355x475x490	1套 / 箱
WB2423S.045.NDG	450	405x475x490	1套 / 箱



→ FEATURES / 产品特点

- Clip-on two way slow motion slides, 53mm soft closing distance
快装、双缓冲功能领先优势，缓冲距离 53mm
- Clip-on two way slow motion slides, with glass multi-basket
联动双缓冲骑马抽轨道，配合环保纳米干镀膜调味拉篮
- For pots, big plates and plastic holders etc
可存放刀叉、筷子、饭勺等小餐具
- Color: Dark grey
颜色：深灰色

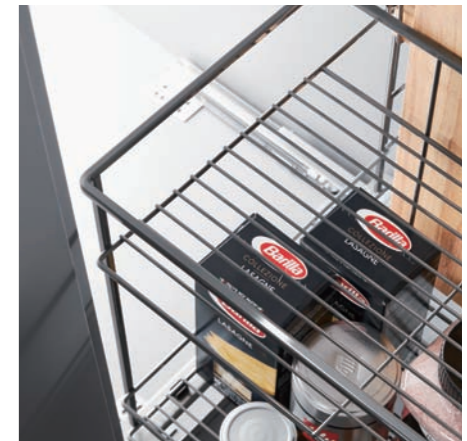
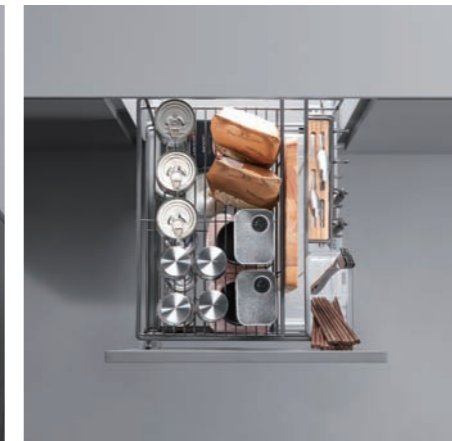
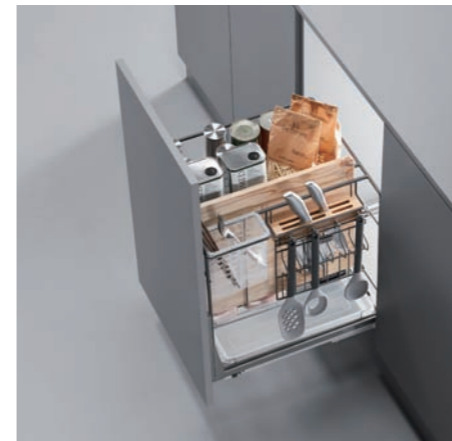

→ TECHNICAL DETAILS / 技术参数

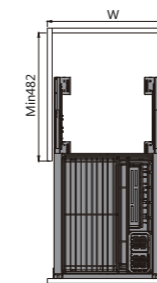

MODEL / 型号	CABINET / 柜体 W (mm)	WIDTH x DEPTH x HEIGHT (mm) 宽 x 深 x 高 (mm) . 含导轨	PACKAGING / 包装数量
WB2429S.030.DG	300	245x475x462	1套 / 箱
WB2429S.035.DG	350	295x475x462	1套 / 箱
WB2429S.040.DG	400	355x475x462	1套 / 箱
WB2429S.045.DG	450	405x475x462	1套 / 箱

SIDE MOUNTED BASKET

纳米侧装调味拉篮

SIMPLE BUT INDISPENSABLE FOR DAILY LIFE.

简洁的外表，掩饰不住卓尔不凡的优雅，轻轻拉合间是它坚毅的品质。在伸展自如间开启大展身手，关于生活，我们本该更自由一些。





→ FEATURES / 产品特点

- Clip-on two way slow motion slides, 53mm soft closing distance
快装、双缓冲功能领先优势，缓冲距离 53mm
- For pots, big plates and plastic holders etc
可存放各种调味瓶
- Clip-on two way slow motion slides, with glass multi-basket
联动双缓冲骑马抽轨道，配合环保纳米干镀膜侧装调味拉篮
- Color: Nano dark grey
颜色：纳米炭灰色



→ TECHNICAL DETAILS / 技术参数

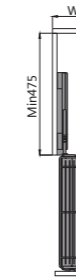

MODEL / 型号	CABINET / 柜体 W (mm)	WIDTH x DEPTH x HEIGHT (mm) 宽 x 深 x 高 (mm) . 含导轨	PACKAGING / 包装数量
WB2335SR.015.NDG	150	108x470x550	1套 / 箱
WB2335SL.015.NDG	150	108x470x550	1套 / 箱
WB2335SR.020.NDG	200	150x470x550	1套 / 箱
WB2335SL.020.NDG	200	150x470x550	1套 / 箱

TWO LAYERS S-TRAY

纳米缓冲扁铁双层旋转飞碟





S-TRAY HELPS THE KITCHEN MAKE FULL USE OF THE CORNER.

双层旋转飞碟，它可以帮助您把转角位置充分利用，实现所有物品拉出柜体，轻松存取。

→ FEATURES / 产品特点

- Soft closing; Make good use of corner space
Basket freely combination
轻柔开启、缓冲关闭；双缓冲功能领先优势
- For pots, big plates etc
可存放各种锅类、大餐盘，收纳瓶罐等
- Clip-on two way slow motion slides, with glass multi-basket
缓冲扁铁双层旋转飞碟，单层载重 15KG
- Color: Dark grey
颜色：深灰色



→ TECHNICAL DETAILS / 技术参数

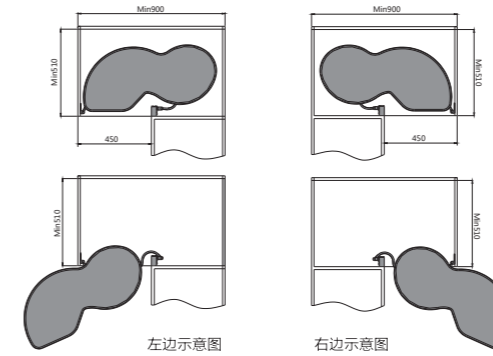

MODEL / 型号	CABINET / 柜体 W (mm)	WIDTH x DEPTH x HEIGHT (mm) 宽 x 深 x 高 (mm) . 含导轨	PACKAGING / 包装数量
WB2202SR.090.DG	900	830x440x540	1套 / 箱
WB2202SL.090.DG	900	830x440x540	1套 / 箱

MAGIC CORNER

纳米板式缓冲小怪物拉篮

MAGIC CORNER HELPS YOU FIND WHAT YOU WANT EASILY.

转角地柜深不可测，总要奋力将手往里伸。纳米缓冲小怪物，让你在旋转之间，即可轻松查看取物。上下两层设计，合理利用空间。



→ FEATURES / 产品特点

- Soft closing; Make good use of corner space
Basket freely combination, left and right installation for option
轻柔开启、缓冲关闭, 转角柜优化解决方案之一;
左、右两边开启方向选择
- For pots, big plates etc
可存放各种锅类、大餐盘, 收纳瓶罐等
- High strength steel frame, movable wood panel basket
高强度钢架结构, 可自由拆装纳米板式防滑挂篮
- Color: Dark grey
颜色: 深灰色



→ TECHNICAL DETAILS / 技术参数

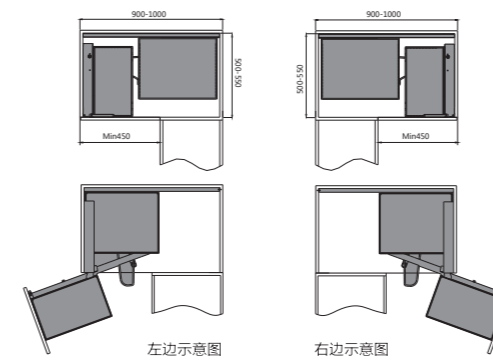

MODEL / 型号	CABINET / 柜体 W (mm)	WIDTH x DEPTH x HEIGHT (mm) 宽 x 深 x 高 (mm) . 含导轨	PACKAGING / 包装数量
WB2106SR.090W.DG	900	860-968x500-550x530	1套 / 箱
WB2106SL.090W.DG	900	860-968x500-550x530	1套 / 箱



→ FEATURES / 产品特点

- Soft closing; Make good use of corner space
Basket freely combination, left and right installation for option
轻柔开启、缓冲关闭，转角柜优化解决方案之一；
左、右两边开启方向选择
- High strength steel frame, movable wire type basket
高强度钢架结构，可自由拆装金属线挂篮
- For pots, big plates etc
可存放各种锅类、大餐盘，收纳瓶罐等
- Color: Chrome
颜色：镀铬



→ TECHNICAL DETAILS / 技术参数

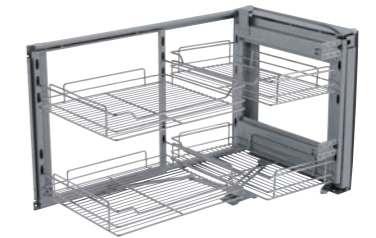
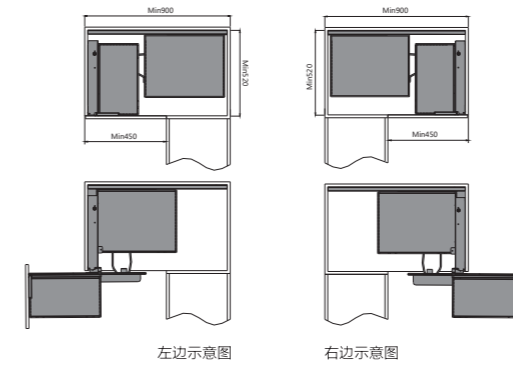

MODEL / 型号	CABINET / 柜体 W (mm)	WIDTH x DEPTH x HEIGHT (mm) 宽 x 深 x 高 (mm) . 含导轨	PACKAGING / 包装数量
WB2106SR.090S.CP	900	860x498x516	1套 / 箱
WB2106SL.090S.CP	900	860x498x516	1套 / 箱

LIFT BASKET

纳米升降吊柜篮





→ FEATURES / 产品特点

- Soft opening, soft closing, adjustable loading capacity, Reasonable use the space of wall cupboard
轻柔开启、缓冲关闭，三种载重可调，可以把吊柜空间巧妙转化为活动空间；吊柜优化解决方案之一
- Strong frame, two layers wire basket
高强度钢架结构，两层金属线篮
- Pans, big plates...
可存放各种锅类、大餐盘，收纳瓶罐等
- Color: Dark grey
颜色：深灰色



→ TECHNICAL DETAILS / 技术参数

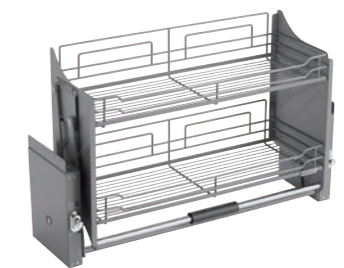
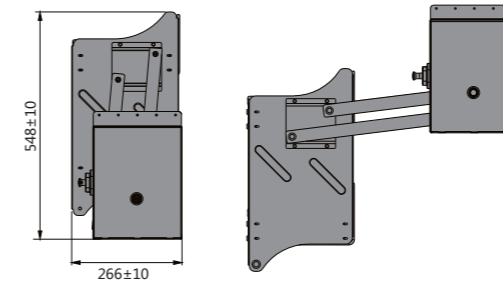

MODEL / 型号	CABINET / 柜体 W (mm)	WIDTH x DEPTH x HEIGHT (mm) 宽 x 深 x 高 (mm) . 含导轨	PACKAGING / 包装数量
WB3302S.060.DG	600	560x280x560	1套 / 箱
WB3302S.070.DG	700	660x280x560	1套 / 箱
WB3302S.080.DG	800	760x280x560	1套 / 箱
WB3302S.090.DG	900	860x280x560	1套 / 箱

